

Technical datasheet

Wedgmounds QFixx 515.2-VRKC /915

Art. no.
1.37515.65

For transport lines, special machines and tool machines. High load capacity, excellent constant leveling stability and overall stability. Compact, dirt protected, low leveling torque

Max. load
12000 daN

| Article information | |
|---------------------|--------------------|
| Type | 515.2-VRKC /915 |
| Name | Wedgmounds QFixx |
| Art. no. | 1.37515.65 |
| Color | RAL 9005 jet black |

Type illustration



System description

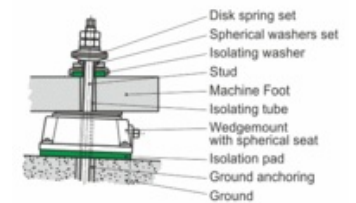

| Technical Data | | Dimensions | |
|--|---------|---|-----|
| Max. load [daN] | 12000 | Height H [mm] | 84 |
| Inclination [°] | 3 | Height H _{0B} in neutral position, without pads [mm] | 69 |
| Leveling range [mm] | 5 | Length L [mm] | 160 |
| Leveling range [mm] | -5 | x [mm] | 80 |
| Leveling distance per turn [mm] | 0.37 | y [mm] | 70 |
| Temperature range from [°C] | -20 | Width B [mm] | 140 |
| Temperature range to [°C] | 80 | Diameter D ₁ [mm] | 113 |
| Weight [kg] | 7.008 | Inner diameter d ₁ [mm] | 21 |
| Pad equipment | | Width across flats SW ₁ [mm] | 17 |
| Bottom pad type | 915 | | |
| Pad thickness unloaded [mm] | 15 | | |
| Coefficient of friction on concrete with fine mortar | 0.8 | | |
| Hardness [° Shore A] | 90 - 95 | | |
| Bottom pad area A ₁ [cm ²] | 218 | | |

Dimensioned sketch

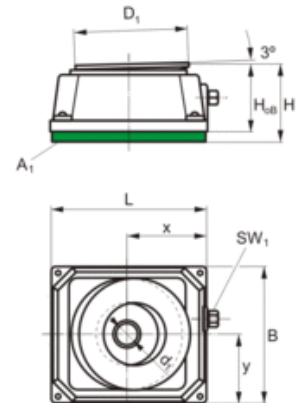



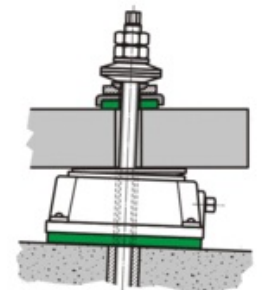

Mounting sketch



| Suitable studs | |
|---|--------------------------------|
|  | Studs RGM more |
|  | Studs S more |

| Useful remarks | |
|---|--|
| Accessories: AirLoc Spacer type 113V-6/12 | |

| Accessories | |
|---|--|
|  | Spherical washers set more |
|  | Disk springs more |
|  | Isolating washers more |
|  | Isolation tubes more |
|  | AirLoc-Spacer more |

| Remark extent of supply | |
|--------------------------------------|--|
| Studs need to be ordered separately. | |