

***AirLoc***

stops vibrations

### THE COMPANY



#### **AirLoc – for innovations in leveling and vibration engineering**

For more than 50 years the name AirLoc has stood for high-quality products in the areas of vibration engineering, impact sound insulation and machine setup technology. When it comes to foundation isolation for newspaper rotary printing presses and machine foundations, we are one of the world's leading suppliers of complete solutions. The quality of our products is ensured by our modern machinery, production depth and our own test laboratory. A worldwide sales network guarantees the availability of our products and services everywhere, anytime. Our location near Zurich is conveniently situated in the heart of Europe.



#### **AirLoc – custom solutions for your ideas**

We produce and market efficient and safe products at a fair price-performance ratio. A broad range of products available from stock is the basis for an economical product selection, high delivery reliability and an excellent reputation with our customers.



#### **AirLoc – for complete one-stop service**

We are a system supplier that offers our customers all-around service. From the planning phase of a project to the installation, we are your one-stop supplier. Our customers profit from our many years of experience because we offer efficient and complete solutions that increase our customers' competitiveness.

### PRODUCTS AND SERVICES



#### **Measurements**

With our modern measurement devices we offer our customers vibration measurements using FFT analyzers. We are able to determine the natural frequencies of buildings and disturbing frequencies of machines of all kinds. The measurement results serve as the basis for a problem analysis from which recommendations for improvement can be derived. Our Dynamometer measurement system permits us to measure static loads in order to determine the exact load distribution of a machine.

#### **Foundation vibration isolation**

One of our key know-how areas is designing custom vibration isolations for any kind of machine foundation. We have designed several hundred foundation isolation systems, even for large-scale foundation blocks of several thousand tons. The vibration isolation systems that we designed were manufactured in-house and properly installed at customer premises under our supervision.

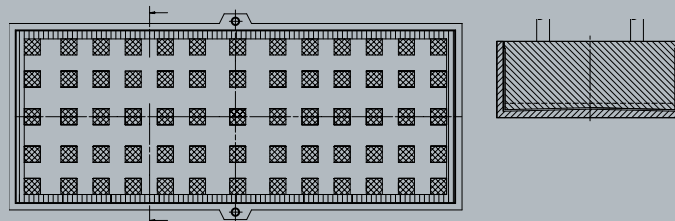

Vibrations generated by machines and equipment are disturbing. The need to reduce vibration transmissions places increasing demands on machine engineers and operators. Targeted vibration prevention is therefore a must.

### VIBRATION ENGINEERING

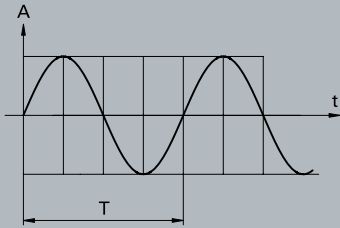

Figure 1: Harmonic vibration

**Figure 1** shows a sinusoidal, undamped vibration. The most important terms in vibration engineering are frequency  $f$ , amplitude  $A$  and damping factor  $D$ . Natural frequency as well as resonance are also important figures when considering isolation systems.

**Frequency  $f$**  is a measure of the number of complete vibration cycles per second.  $f = \frac{1}{T}$  [ $\frac{1}{s} = \text{Hz}$ ]

**Structure-borne noise** are vibrations that are conveyed in a solid body. Low frequencies are generally what we call mechanical vibrations.

The **amplitude** is the vibration wave range around its equilibrium. It determines the severity of vibration and is usually expressed in terms of acceleration or displacement.

**Damping  $D$**  designates the measure of amplitude reduction of the vibration of a freely oscillating spring-mass system through friction. Damping refers to the conversion of energy to heat.

**Natural frequency  $f_0$**  of a body is the frequency with which the body freely oscillates around its equilibrium without external influence. Each body has its own natural frequency, which however can only be calculated in the simplest of cases. Usually it can be easily measured using impact or impulse triggering. If this natural frequency is close to a vibration forcing frequency  $f_E$ , **resonance** is the result. In this case the amplitude increases, which could lead to the destruction of the system.

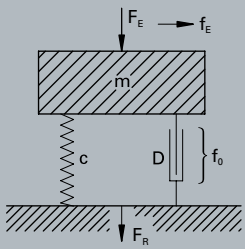

Figure 2: Vibration isolation of a dynamic system

### VIBRATION ISOLATION

The vibration isolation of a dynamic system consists of isolating from the environment by means of an elastic body which has a considerably lower natural frequency  $f_0$  from the system forcing frequency  $f_E$ .

**Figure 2** schematically shows such a system with isolation. Of practical interest is the transmitted force  $F_R$  output and ratio of this force to the original input force. This ratio, called force transmission factor  $V_K$ , is shown in **Figure 3** as a function of the frequency ratio.

$$\eta = \frac{f_E}{f_0}$$

For  $\eta = \sqrt{2}$  the  $V_K$  becomes 1 again and above  $\eta = \sqrt{2}$  the result is isolation. The greater the ratio of vibration generator frequency  $f_E$  to natural  $f_0$ , the better the degree of isolation  $J = 1 - V_K$ .

When elastic materials are used, it has been determined that below the resonance range of about  $\eta = 0,5$  the vibration acceleration values are reduced and therefore isolation is provided.

The natural frequency as a function of the specific load must be determined for elastomers in laboratory measurements. The measurable reduction in thickness of the plates is designated compressive static deflection.

### VIBRATION ISOLATED MACHINE SETUP

The demands for machine setup are nearly always contradictory. The machine should be firmly fixed and stable but well isolated against vibration. It should be quickly and easily assembled (and disassembled) but it should not move. And it should also be able to be leveled and re-leveled with great precision, but not displaced.

This is where the considerable practical experience of AirLoc Ltd. comes into play to find the right custom solution.

- $m$  = mass
- $c$  = spring constant
- $D$  = damping core size

}  $f_0$

- $f_0$  = natural frequency of the isolation
- $f_E$  = vibration generator frequency

}  $\eta = \frac{f_E}{f_0}$  Frequency ratio

- $F_E$  = generator force
- $F_R$  = remaining force

}  $V_K = \frac{F_R}{F_E}$  force transmission factor

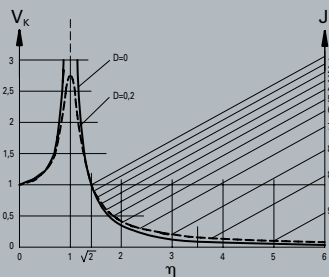

Figure 3: Force transmission factor as a function of the frequency ratio

$$V_K = \frac{F_R}{F_E} = \sqrt{\frac{1+(2D\eta)^2}{(1-\eta^2)^2+(2D\eta)^2}}$$

The AirLoc selection table is designed to help you find the right AirLoc Jacmount® Adjustable Levelers or AirLoc Wedgmount® Precision Levelers for your machine.

**Is your machine or your specific application not listed?**

Please contact us by e-mail, telephone or fax. Our experienced team will help you with your selection. You will find the contact details on the last page of this catalogue.

Areas of application	Jacmount® Adjustable Levelers pages 14 – 23			Wedgmount® Precision Levelers pages 24 – 35				Engineering solutions pages 12 – 13		
	GLV, GLR and GLRI GLRN and GLP	Bolted onto the machine			Free standing	Bolted onto the machine	Bolt-through anchored in the floor	Rigid clamp without isolation lining	Pad sets	Foundation isolation
		PRS	PRG PGRI	PRP						
<b>Metal processing</b>					●	●	●	●	●	
Machining centres	○				●				●	
Drilling machines							●	●	●	
Boring machines	○		●		●					
Lathes							●	●	●	
Lathes, long bed	○	●	●		●			●	●	
Milling machines		●	●		●					
Pumps and compressors				●		●			●	
Presses, mechanical					●	●		●	●	
Presses, hydraulic	○		●		●					
Saws						●	●	●	●	
Shears and folding presses		●			●			●	●	
Grinding machines								●	●	
Forging machines		●		●		●		●		
Stamping and nibbling machine					●	●	●	●		
Transfer lines										
<b>Plastic processing</b>		●	●		●					
Granulators						●		●		
Mills and calenders							●			
Handling devices	●	●	●	●	●	●				
Injection moulding machine										
<b>Printing and paper industry</b>	●		●					●		
Book-binding machines	○		●		●	●	●	●	●	
Printing presses			●		●	●		●		
Folders	○		●		●	●		●		
Paper cutters	●		●		●					
Packaging machinery										
<b>Other machines</b>	●		●		●					
Chemical installations (INOX)	○	●	●	●	●	●				
Woodworking machines			●		●		●	●	●	
Air conditioners	○	●	●					●	●	
Measuring instruments	●		●							
Food industry (INOX)			●					●	●	
Optical devices	○		●		●	●		●		
Web machines										

● The leveler is optimally suited for this application.  
On the catalogue page of the selected machine element, please look for a suitable element to match your application and machine weight.

○ For light-weight machines only  
If you are not certain, please ask us or use PRG and PGRI elements.

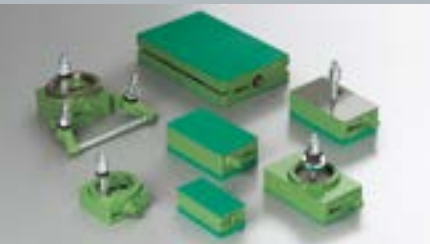
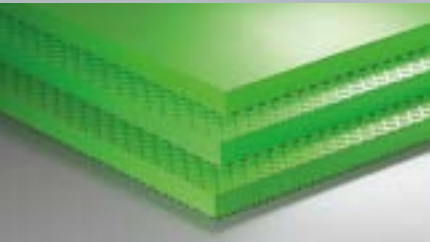

	Page
<b>AirLoc isolation pads</b>	<b>6</b>
400 series	7
700 series	8
900F series	9
Composite pads series	10
Non-skid and shim pads	11
Multi layered pads	12
<b>Foundation isolation</b>	<b>13</b>
<b>AirLoc Jacmount® Adjustable Levels</b>	<b>14</b>
PRG	15
PRS and PRSK	16
PRP	17
GLV and GLR	18
GLRN	19
PRGI and GLRI – INOX stainless steel	20
PR – thermoplastic	21
Custom designs	22
<b>AirLoc Wedgmount® Precision Levels</b>	<b>24</b>
VRC – free standing	26
VRC – free standing, 4-wedge system	27
VRC – bolt-on	28
VRKC – bolt-on, spherical seat	29
VRC – bolt-through	30
VRKC – bolt-through, spherical seat	31
KSC – rigid clamp	32
KSKC – rigid clamp, spherical seat	33
KaBloc	34
<b>Fastening systems and studs</b>	<b>35</b>
– Stud type P and TA/SL heavy duty dowel	
– Stud type RGM and RM chemical dowel	
– Isolating washers	
– Stud type S (see page 19)	
– Stud type S INOX (see page 21)	
<b>Custom designs – precision levels</b>	<b>36</b>
<b>Accessories</b>	<b>37</b>
– Spacer for Wedgmount® Precision Levels	
– Mounting Wedgmount® MSC	
– Leveling screw extension	
<b>Horizontal supports</b>	<b>38</b>
Wedgmount® Precision Leveler VC Compact and L2 bracket support	38
HZA – W and H series	39

AirLoc is the only manufacturer offering conventional laminated pad materials and the new generation of advanced isolation pads.

**Of course all AirLoc pad materials are RoHS certified.**

Today's machines generate dynamic forces that were unthinkable a few years ago. AirLoc's new generation of isolation pads are highly developed materials for preventing problems due to vibrations and structure-borne noise. This new generation of pads effectively combats these problems. The technical and physical values are in line with the latest state of elastomer development and today cover application areas that were not possible a few years ago. Improved compression set and coefficient of friction maintain your machine's stability in the specified position for years, even when the dynamic load is high. Excellent resistance to all coolants, cleaning agents and lubricants used in modern machine engineering operations means that these products can be reliably used trouble-free (e.g. in oil troughs).

AirLoc pad materials can be easily cut with a ribbon saw, keyhole saw or disk saw to the desired shape. And of course all AirLoc pad materials are RoHS certified.

With our vibration isolation pads, all vibration-caused problems common to today's machine engineering operations can be solved economically and efficiently.



### **400 Series – the best for outstanding vibration isolation**

AirLoc vibration pads of the 400 series have been specially developed for low-frequency applications. Provides very good resistance to many chemicals, lubricants and fuels guarantees long service life. A high coefficient of adhesion and very narrow production tolerances offer a high level of application security and the best protection for your valuable equipment.

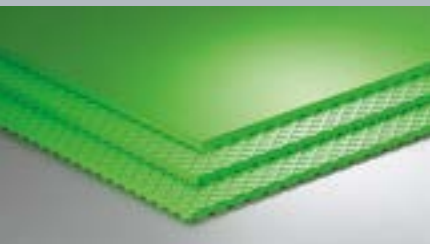

### **700 Series – universal use for excellent damping**

AirLoc vibration pads of the 700 series are the result of 50 years of development and application experience in vibration engineering. Thanks to the high level of damping, the application is secure and extremely effective, even when used in critical operational conditions. Very good resistance to oils, lubricants and fuels makes the 700 series isolation pads ideal for modern, cost-effective production machines and machine tools.



### **900F Series – dynamic for greatest load-bearing capacity**

AirLoc vibration isolation pads of the 900F series were developed for all applications with high static and dynamic forces and for the greatest leveling stability. The very high load-bearing capacity and very good resistance to many chemicals, lubricants and fuels guarantee long service life. This makes the 900F series isolation pads the ideal material for modern, cost-effective production machines and machine tools.

## 400 Series – the best for outstanding vibration isolation

AirLoc vibration isolation pads of the 400 series have been specially developed for low-frequency applications. Provides very good resistance to many chemicals, lubricants and fuels guarantees long service life. A high coefficient of adhesion and very narrow production tolerances offer a high level of application security and the best protection for your valuable equipment.

Order no. = article no. + index	Area of application	Type	Article no.	Pad thickness	Load	Natural frequency, medium load (Hz)	
				mm	daN/cm <sup>2</sup>	vertical	horizontal
	Sensitive devices that are affected by vibrations. Low structure height.	<b>410</b> without profile	2.00100.__	10	2.5 – 10	50	6.5
	Highly effective isolation for sensitive devices that are affected by vibrations.	<b>425</b> without profile	2.00425.__	25	2.5 – 7.5	22	4.5
	Production machines on multi storied buildings, measuring machines.	<b>B1</b> profile both sides	2.00132.__	13	1 – 5	21	6
	Passive isolation for sensitive devices, e.g. laboratory instruments and weighing equipment.	<b>B2</b> profile both sides	2.04202.__	26	1 – 5	14	5
	Foundation isolations, passive isolation for very sensitive devices and systems.	<b>B3</b> profile both sides	2.04203.__	39	1 – 5	10	4
		<b>B4</b> profile both sides	2.04204.__	52	1 – 5	9	3.5
Temperature range Coefficient of friction Shore hardness	-20 °C to +80 °C 0.9 40 – 45° Shore A	Standard pad sizes 400 series	Index	L mm	W mm	Only types 410 and 425	
Other dimensions in all shapes available from stock upon request.			___.70 ___.71 ___.72 ___.76 ___.80 ___.85 ___.86	1000 500 500 250 200 125 100	500 500 250 250 200 125 100		

Multi-layered pads, see page 12, pad sets. For more information please visit our website.

## 700 Series – universal use for excellent damping

AirLoc vibration pads of the 700 series are the result of 50 years of development and application experience in vibration engineering. Thanks to the high level of damping, the application is secure and extremely effective, even when used in critical operational conditions. Very good resistance to oils, lubricants and fuels makes the 700 series isolation pads ideal for modern, cost-effective production machines and machine tools.

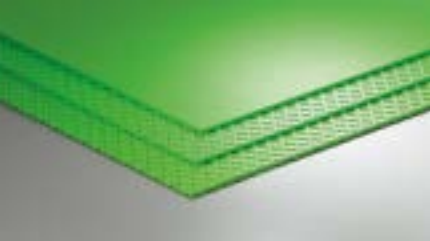
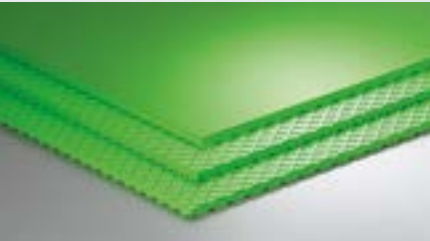
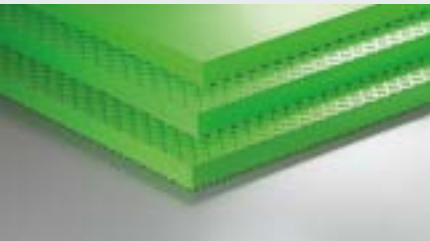
Order no. = article no. + index	Area of application	Type	Article no.	Pad thickness	Load	Natural frequency, medium load (Hz)	
				mm	daN/cm <sup>2</sup>	vertical	horizontal
	Economical isolation pad with high damping. Low structure height. Suitable for production systems, general machine engineering.	<b>710</b> without profile	3.07100.__	10	5 – 20	92	19
		<b>711</b> profile one side	3.07101.__	10	5 – 20	77	18
		<b>712</b> profile both sides	3.07102.__	10	5 – 20	71	17
	Universally usable isolation pad with high damping effect. Many years of proven performance in all printing presses, paper and textile machines.	<b>715</b> without profile	3.07150.__	15	5 – 20	81	13
		<b>716</b> profile one side	3.07151.__	15	5 – 20	67	16
		<b>717</b> profile both sides	3.07152.__	15	5 – 20	58	15
	Highly effective isolation pad especially developed for machines with high dynamic force, such as presses, sheering machines and stamping machines.	<b>725</b> without profile	3.07250.__	25	5 – 20	44	10
		<b>726</b> profile one side	3.07251.__	25	5 – 20	33	8
		<b>727</b> profile both sides	3.07252.__	25	5 – 20	33	8

Temperature range –15 °C to +100 °C  
Coefficient of friction 0.8  
Shore hardness 70 – 75° Shore A

Standard pad sizes 700 series	Index	L mm	W mm
Other dimensions in all shapes available from stock upon request.	___.70	1000	500
	___.71	500	500
	___.72	500	250
	___.76	250	250
	___.80	200	200
	___.85	125	125
	___.86	100	100

Multi-layered pads, see page 12, pad sets. For more information please visit our website.



## 900F Series – dynamic for greatest load-bearing capacity

AirLoc vibration isolation pads in the 900F series have been developed for all applications with high static and dynamic forces and for the greatest leveling stability. The very high load-bearing capacity and very good resistance to many chemicals, lubricants and fuels guarantee long service life. This makes the 900F series isolation pads the ideal material for modern, cost-effective production machines and machine tools.

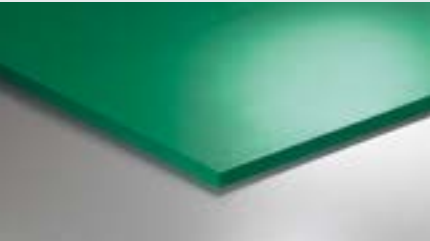
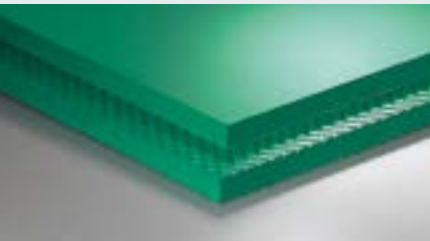

Order no. = article no. + index	Area of application	Type	Article no.	Pad thickness	Load	Natural frequency, medium load (Hz)	
				mm	daN/cm <sup>2</sup>	vertical	horizontal
	Economical isolation pad for high static loads. Low structure height. For machining centers, machine tools with the highest level of constancy.	<b>910F</b> without profile	3.09100.__	10	7.5 – 40	70	21
	High load capacity isolation pads, especially for transfer lines and long-bed machines.	<b>915F</b> without profile	3.09150.__	15	7.5 – 40	62	18
	Isolation pad for machines with high dynamic force, such as presses, sheering machines and stamping machines.	<b>925F</b> without profile	3.09250.__	25	7.5 – 40	42	14
		<b>927F</b> profile both sides	3.09252.__	25	7.5 – 30	39	12

Temperature range –20 °C to +80 °C  
Coefficient of friction 0.8  
Shore hardness 90 – 95° Shore A

Standard pad sizes 900F series	Index	L mm	W mm
<b>Other dimensions in all shapes available from stock upon request.</b>	____.70F	1000	500
	____.71F	500	500
	____.72F	500	250
	____.76F	250	250
	____.80F	200	200
	____.85F	125	125
	____.86F	100	100

Multi-layered pads, see page 12, pad sets. For more information please visit our website.

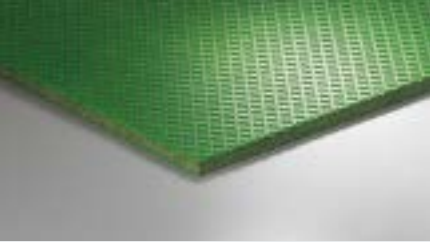
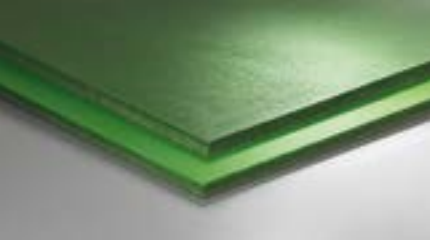
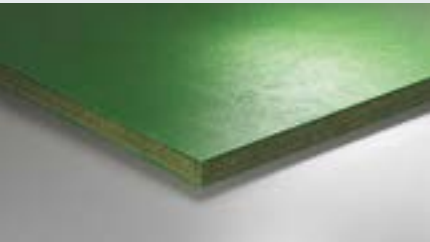
AirLoc vibration isolation pads in composite quality for all applications have been tried and proven for over 50 years. Many years of experience and thousands of successful applications make these pads the ideal material for any kind of machine setup.

Order no. = article no. + index	Area of application	Type	Article no.	Pad thickness	Load	Natural frequency, medium load (Hz)	
				mm	daN/cm <sup>2</sup>	vertical	horizontal
	Universally applied. Well suited for machine tools and printing presses.	<b>4.17.4</b> profile both sides	1.00402.____	15.5	3 – 8	53	13
	Isolation pads with very high level stability, especially for transfer lines and machining centres.	<b>610</b> without profile	1.00610.____	14	10 – 30	59	12
	High load capacity isolation pads for heavy-duty transfer lines and long-bed machines.	<b>4.17.6</b> without profile	1.00600.____	14.5	10 – 30	61	16
	High load capacity isolation pads for machines with high dynamic force.	<b>4.17.50</b> without profile	1.00500.____	25.5	6 – 20	45	9
	Soft isolation pads for highly effective vibration isolation of presses and stamping machines, also on multi storied buildings.	<b>32</b> profile both sides	1.00302.____	22	1 – 3	31	11

Temperature range 0 °C to +70 °C  
Coefficient of friction 0.6 – 0.8

Standard composite pad sizes	Index	L mm	W mm
Other dimensions in all shapes available from stock upon request.	____.70	1000	500
	____.71	500	500
	____.72	500	250
	____.76	250	250
	____.80	200	200
	____.85	125	125
	____.86	100	100

Multi-layered pads, see page 12, pad sets. For more information please visit our website.

## Non-skid and shim pads

AirLoc non-skid and shim pads are used as intermediate shims between two steel surfaces or to compensate different heights when a machine is set up. The use of top, proven materials mean applications you can count on for a long machine life.

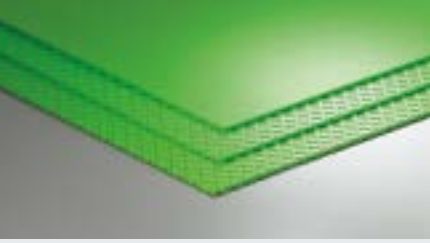
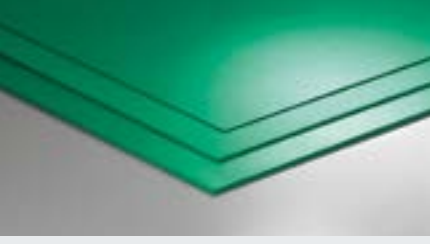
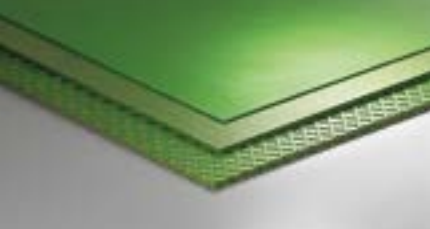
Order no. = article no. + index	Area of application	Type	Article no.	Pad thickness	Load	Natural frequency, medium load (Hz)	
				mm	daN/cm <sup>2</sup>	vertical	horizontal
	Excellent non-skid properties.	<b>405</b> without profile	2.00050.__	5	2.5 – 10	–	–
	Universally applied, long-term stability.	<b>705</b> without profile	3.07050.__	5	5 – 20	–	–
		<b>706</b> profile one side	3.07051.__	5	5 – 20	–	–
		<b>707</b> profile both sides	3.07052.__	5	5 – 20	–	–
	High load capacity, good leveling stability, high long-term stability.	<b>902F</b> without profile	3.09020.__F	2	7.5 – 40	–	–
		<b>903F</b> without profile	3.09030.__F	3	7.5 – 40	–	–
		<b>905F</b> without profile	3.09050.__F	5	7.5 – 40	–	–
	Proven quality with excellent form stability.	<b>SP0</b> without profile	1.00000.__	2.5	10 – 30	–	–
		<b>S0</b> without profile	1.00200.__	5.5	10 – 30	–	–
		<b>SL</b> profile both sides	1.00222.__	7	4 – 12	–	–

Temperature range:  
**400 and 900F** –20 °C to +80 °C  
**700** –15 °C to +100 °C  
**SP0, S0 and SL** 0 °C to +70 °C

Coefficient of friction 0.6 – 0.9

Standard pad sizes for non-skid and height compensation pads	Index	L mm	W mm
Other dimensions in all shapes available from stock upon request.	___.70	1000	500
	___.71	500	500
	___.72	500	250
	___.76	250	250
	___.80	200	200
	___.85	125	125
	___.86	100	100

Multi-layered pads, see page 12, pad sets. For more information please visit our website.

If the properties of the individual isolation pads are insufficient for optimal vibration isolation, isolation pads can be layered for additional adjustment. By layering 2 to 4 isolation pads to a set, the vertical natural frequency is reduced and effective vibration isolation is achieved.

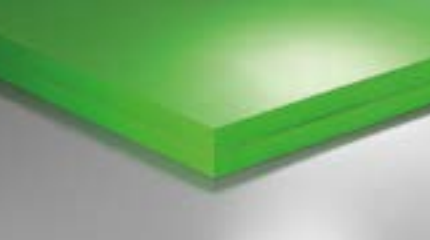
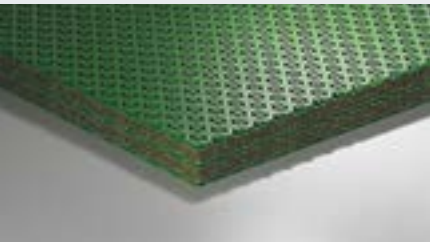
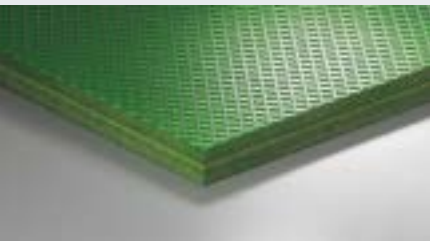
Order no. = article no. + index	Area of application	Type	Article no.	Pad thickness	Load	Natural frequency, medium load (Hz)	
				mm	daN/cm <sup>2</sup>	vertical	horizontal
	Soft quality for low-frequency isolation jobs, passive isolation of building vibrations, tiered machine setup, laboratory instruments, microscopes, EDP systems, analysis scales, foundation isolation.	<b>B2</b> profile both sides	2.04202.__	26	1 – 5	14	–
		<b>B3</b> profile both sides	2.04203.__	39	1 – 5	10	–
		<b>B4</b> profile both sides	2.04204.__	52	1 – 5	9	–
	This 70° shore A material is characterised by very high damping and is therefore especially suitable for isolating setups of presses and similar machines. No profile, good non-skid properties.	<b>K813</b> without profile	3.04813.__	50	5 – 20	27	–
	Well suited as soft foundation isolation material. It is primarily used under foundations of presses and large machine tools of all kinds.	<b>K975</b> profile both sides	1.04975.__	44	1 – 3	18	–
	Well suited as standard quality for foundation isolations. It is primarily used under large foundations of newspaper printing presses and other heavy machines with big dimensions.	<b>K905</b> profile both sides	1.04905.__	36.5	3 – 8	36	–

Temperature range 0 °C to +70 °C  
Coefficient of friction 0.6 – 0.8

Standard pad sizes for pad sets	Index	L mm	W mm	
<b>Other dimensions in all shapes available from stock upon request.</b>	___.70	1000	500	Only types K813, K975, K905
	___.71	500	500	
	___.72	500	250	
	___.76	250	250	
	___.80	200	200	
	___.85	125	125	
	___.86	100	100	

For more information please visit our website.

Foundations are for making a machine rigid or for gathering several machine components onto a common load-bearing ground. The additional weight of the foundation has a positive effect on the vibration behaviour. However, there are limits to this positive effect. Only by using vibration isolation and the resulting decoupling from the building ground can the area be reliably protected against disturbing vibrations.

AirLoc has many years of experience in designing foundation isolations. From the first vibration analysis to the site inspection of the laid foundation, we are your one-stop supplier.



Figure 1:  
Foundation tank before installing the vibration isolation pads



Figure 2:  
After installing the isolation (green)



Figure 3:  
Block preparation for pouring the foundation



Figure 4:  
Web rotary press

### The basic principle of foundation isolation

The machine foundation is placed in a concrete tank for vibration isolation. Between foundation block and tank there is a layer of vibration isolation material. The calculation of this isolation layer requires considerable know-how and many years of experience in the vibration engineering.

Key parameters are:

- Total weight of foundation and machine
- Dynamic forces and moments of the machine
- Natural frequencies of the system
- Vibration isolation efficiency.

### AirLoc isolation system for foundation isolation

The AirLoc foundation isolation has the following characteristic properties:

- Complete isolation of the machine block in vertical and horizontal directions
- Tuning the isolation frequency through project-specific design (number and distribution of the isolation pads) based on the effective load bearing mass, i.e. the customer-specific conditions.

In contrast to full surface isolations, the AirLoc isolation pads are adapted in terms of variable dimensions and number to the particular project. The AirLoc foundation isolation is calculated based on the effective load and laid according to the specific area. This permits tuning the full area of the installed foundation isolation to the current conditions.

### Implementation example

The implementation of a foundation isolation system for a web rotary press documents the large-scale dimensions that are involved. Figure 1 shows the foundation tank before laying the isolation pads. In Figure 2 they are already laid. The actual vibration isolation elements are the green pads. Between them are the systems we have developed. This protects the covered vibration isolation material from the reinforcement and foundation concrete (Figure 3). After completion of the machine installation, the foundation can hardly be seen (Figure 4).

AirLoc Jacmount® Adjustable Levelers are characterised by their simple and effective construction. Continuous inspection of the raw materials by our in-house laboratory and our own production facilities ensure the highest possible quality without sacrificing cost-efficiency.

A broad range of products makes it easy to select the elements to suit your needs and helps you keep costs down without having to compromise quality.

**Of course all AirLoc Jacmount® Adjustable Levelers are RoHS certified.**



**PRG elements** are designed to make it easy, economical and reliable to set up your machine or system. The patented connection between the levelers and the leveling screws is permanent, has a high load capacity, and can automatically compensate ground unevenness of up to 4°. The anchor-free setup and the simple leveling with great leveling range guarantee maximum flexibility of your machinery.

**PRS and PRSK levelers** are a new development from AirLoc, especially for machines with high dynamic horizontal force. The robustly designed base plate is permanently connected to a pressure plate by means of precision guide. This design principle enables the greatest possible horizontal rigidity over the entire leveling range.

**PRP levelers** are excellently suited to quick and precise machine setups of up to 10 tons per foot. There is an easy and reliable connection between floor surface and your machine. The special construction of the pressure plate makes it possible to compensate ground unevenness of up to 4° while ensuring outstanding horizontal stability.

**GLV and GLR levelers** are proven-performance economical products from AirLoc. They are deployed when dependable vibration and impact sound isolation is required for machines that have suitable leveling screws in the machine foot. The mounting sink for the leveling screw is shaped so that skewing is not possible and ground unevenness is balanced.

**GLRN levelers** with interchangeable leveling sockets can be economically and flexibly deployed. The levelers can be raised up to +13 mm in height. Depending on the leveler socket in use, the connection to your machine can be bolted, anchored or custom designed as you require.

**Stainless steel PRGI levelers** are permanently attached to the leveling screw by means of a patented lock and yet are flexible enough that ground unevenness up to 4° can be leveled. When used with no-profile damping pads, they are ideally suited for the food and chemical industries.

**PR levelers** are made of reinforced thermoplastic. They are excellently suited to light machinery and applications requiring a high level of cost-efficiency. The studs of the PR levelers are quickly mounted and permanently anchored in the leveler, yet so flexible that ground unevenness up to 4° can be balanced.

If you have not found the optimal leveling elements despite the large selection range, please ask about our custom designs. We would gladly provide you with custom-made products based on your requirements. Phone us or send us your ideas as a sketch or drawing.

**Your color is important to you! To us too!**

**This is why we can deliver in any color. Ask us – we'll make it possible.**

PRG Jacmount® Adjustable Levelers are designed to make it easy, economical and reliable to set up your machine or system. The patented connection between leveler and leveling screw is permanent, has a high load capacity, and can automatically compensate ground unevenness of up to 4°. The anchor-free setup and the simple leveling with great leveling range guarantee maximum flexibility of your machinery.

Ask us also about our custom solutions for your specific machine.

Order no. =  
article no. + index

Color:  
Silver grey RAL 7001

Other colors  
upon request

**The Best**  
Extremely stable.  
Best suited for light  
machines and systems  
for which there  
is permanently defined  
ground contact.

**The Universal**  
Application secure  
thanks to high level of  
damping. Very good  
stability due to high  
ground adhesion.

**The Load Bearer**  
For applications with  
high static load. Excellent  
leveling stability  
and high overall stability.  
Very economical.

Pad type  
Index

**405**  
\_.43

**705**  
\_.58

**905**  
\_.73

Dimension

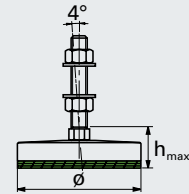
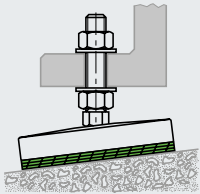

Type	Article no.	Load daN	h max. mm	Load daN	h max. mm	Load daN	h max. mm	Ø mm	Leveling screw
PRG 85	1.16085.____	450	38	900	38	1400	38	85	G1
PRG 125	1.16125.____	1000	51	2000	51	3000	51	125	G2
PRG 170	1.16170.____	2000	51	4000	51	4500	51	170	G2
PRG 230	1.16230.____	3500	51	6000	51	6000	51	230	G2

### Special studs G1 and G2 for PRG Jacmount® Adjustable Levelers

Blue zinc-plated. Delivery including 1 self-locking collar + 1 nut + 1 washer for M10, M12, M16 or 2 nuts + 2 washers for M20, M24

Thread	Order no. G1	Order no. G2	L mm	H mm	SW mm
M10	9.55102		100	40	13
M12	9.55122		100	41	13
M16	9.551621		100	49	17
M16		9.551622	100	52	19
M20		9.55202	100	63	22
M24		9.55242	100	74	24

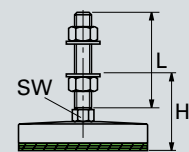

Didn't find the right thread? Ask about our low-priced custom M10 – M30 screws in lengths of 75 to 500 mm. For more information please visit our website.

# PRS and PRSK Jacmount® Adjustable Levelers

PRS Jacmount® Adjustable Levelers are a new development from AirLoc, especially for machines with high dynamic horizontal force. The robustly designed base plate is permanently connected to a pressure plate by means of precision guide. This design principle enables the greatest possible horizontal rigidity over the entire leveling range. When using the high damping AirLoc isolation pads, the machine remains stable even when there are great disturbing forces.

PRSK Jacmount® Adjustable Levelers with spherical seat top parts are ideal for compensating ground unevenness of up to 3°.

Ask us also about our custom solutions for your specific machine.

Order no. =  
article no. + index

Color:  
Silver grey RAL 7001

Other colors  
upon request

**The Economiser**  
For secure non-skid machine fixation without vibration isolation. Extremely high degree of horizontal stability.

**The Dynamic One**  
For presses, stamping and injection moulding machines, machines with high dynamic vertical force. Fast and effective movement damping.

**The Stabiliser**  
For injection moulding machines, machines with high dynamic horizontal force.

Pad type  
Index

**705**  
...58

**725**  
...68

**910**  
...75

Dimension

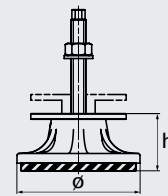
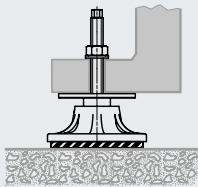

Type	Article no.	Load daN	h mm	Load daN	h mm	Load daN	h mm	Thread	Ø mm	Adjust. range mm
PRS 130-16	1.17130-16_...	2250	55	2250	75	3000	60	M16 x 1.5	129	+20
PRS 130-20	1.17130-20_...	2250	55	2250	75	3000	60	M20 x 1.5	129	+20
PRS 240-20	1.17240-20_...	6000	75	6000	95	7000	80	M20 x 1.5	239	+30
PRS 240-24	1.17240-24_...	6000	75	6000	95	7000	80	M24 x 2.0	239	+30

Other thread sizes upon request

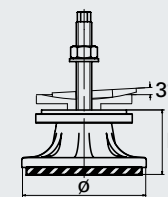
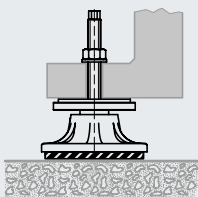

Type	Article no.	Load daN	h mm	Load daN	h mm	Load daN	h mm	Thread	Ø mm	Adjust. range mm
PRSK 130-16	1.17131-16_...	2250	63	2250	83	3000	68	M16 x 1.5	129	+20
PRSK 130-20	1.17131-20_...	2250	63	2250	83	3000	68	M20 x 1.5	129	+20
PRSK 240-20	1.17241-20_...	6000	89	6000	109	7000	94	M20 x 1.5	239	+30
PRSK 240-24	1.17241-24_...	6000	89	6000	109	7000	94	M24 x 2.0	239	+30

Other thread sizes upon request

You will find the matching leveling screws on page 17.  
For more information please visit our website.



PRP levelers are excellently suited for quick and precise machine setups. The selected AirLoc types cover a broad range of machine setups. The special construction of the pressure plate makes it possible to compensate ground unevenness of up to 4° while ensuring outstanding horizontal stability.

Ask us also about our custom solutions for your specific machine.

Order no. =  
article no. + index

Color:  
Zinc chrome RAL 1018

Other colors  
upon request

### The Best

For stamping and nibbling machines and compressors. Best isolation effect, high stability and good damping.

### The Dynamic One

For presses, stamping and injection moulding machines, machines with high dynamic vertical force. Fast and effective movement damping.

### The Stabiliser

For injection moulding machines, machines with high dynamic vertical force. Extremely high degree of horizontal stability.

Pad type  
Index

425

.....48

725

.....68

925

.....64

Dimension

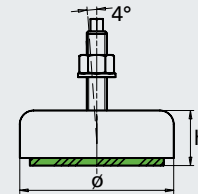
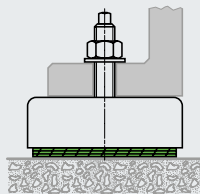

Type	Article no.	Load daN	h mm	Load daN	h mm	Load daN	h mm	Thread	Ø mm	Adjust. range mm
PRP 90	1.15091.____	400	50	1000	50	1500	50	M12 x 1.5	101	+20
PRP 120	1.15120.____	600	50	1500	50	2000	50	M16 x 1.5	123	+25
PRP 160	1.15160.____	1200	52	3000	52	3500	52	M20 x 1.5	168	+25
PRP 200	1.15200.____	1750	54	4000	54	4000	54	M24 x 2.0	205	+25
PRP 250HD	1.15253.____	3000	60	8000	60	8000	60	M27 x 2.0	260	+25
PRP 300HD	1.15302.____	4500	73	10000	73	10000	73	M30 x 2.0	305	+25

### Leveling screws

Blue zinc-plated. Delivery includes 1 nut + 1 washer

### PRP

bolt-through R1

### PRP

with large hex head R2

### PRS and PRSK

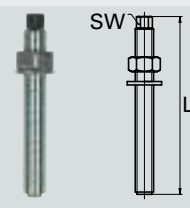
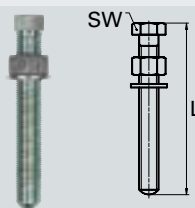
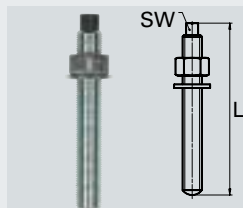

Thread	PRP bolt-through R1			PRP with large hex head R2			PRS and PRSK		
	Order no. L 125 mm	Order no. L 175 mm	SW mm	Order no. L 125 mm	Order no. L 175 mm	SW mm	Order no. L 150 mm	Order no. L 175 mm	SW mm
M12 x 1.5	9.05123		8	9.06123		13			
M16 x 1.5	9.05163	9.05165	10	9.06163	9.06165	17	9.60164		12
M20 x 1.5	9.05203	9.05205	13	9.06203	9.06205	24	9.60204	9.60215	15
M24 x 2.0	9.05243	9.05245	17	9.06243	9.06245	27		9.60245	17
M27 x 2.0	9.05273	9.05275	19	9.06273	9.06275	27			
M30 x 2.0	9.05303	9.05305	22	9.06303	9.06305	36			

Didn't find the right thread? Ask about our low-priced custom M10 – M30 screws in lengths of 75 to 500 mm. For more information please visit our website.

# GLV and GLR Jacmount® Adjustable Levelers

The economical, tried and proven AirLoc GLV and GLR Jacmount® Adjustable Levelers are deployed when dependable vibration and impact sound isolation is required for machines that have suitable fastening holes in the machine foot. The mounting sink for the leveling screw is shaped so that ground unevenness is leveled.

Ask us also about our custom solutions for your specific machine.

Order no. =  
article no. + index

Color:  
Reseda green RAL 6011

Other colors  
upon request

### The Best

For laboratory instruments, passive placement of sensitive devices and machine placement in tiers. Best vibration isolation despite low installation height.

### The Stabiliser

For transport lines and special machines. Excellent constant leveling stability and overall stability. Very low installation height.

### The Universal

For tool, plastic and textile machines, graphic and general production machines. Superior isolation and damping properties. Excellent non-skid properties.

### The Dynamic One

For machines with high static load. Excellent leveling stability and high overall stability even with great disturbance forces.

Pad type  
Index

**B1**

.....50

**711**

.....92

**716**

.....56

**915**

.....65

**Dimension**

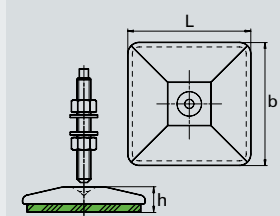
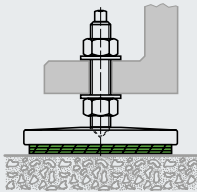

Type Article no.

Load daN

h mm

Load daN

h mm

Load daN

h mm

Load daN

h mm

L mm

b mm

GLV 50 1.10050.\_  
GLV 75 1.10075.\_  
GLV 100 1.10100.\_  
GLV 110 1.10110.\_  
GLV 115 1.10115.\_  
GLV 150 1.10150.\_  
GLV 165 1.10165.\_  
GLV 175 1.10175.\_

90  
250  
500  
600  
500  
900  
1000  
1750

20  
23  
25  
25  
27  
28  
30  
31

200  
800  
1500  
1750  
2000  
2750  
4000  
4500

17  
20  
22  
22  
24  
25  
27  
28

200  
800  
1500  
1750  
2000  
2750  
4000  
4500

22  
25  
27  
27  
29  
30  
32  
33

200  
800  
1500  
1750  
2500  
2750  
4000  
4500

22  
25  
27  
27  
29  
30  
32  
33

50  
81  
108  
123  
148  
145  
199  
243

50  
81  
108  
123  
91  
145  
123  
163

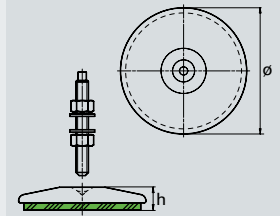
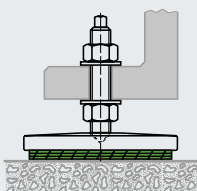

Type Article no.

Load daN

h mm

Load daN

h mm

Load daN

h mm

Load daN

h mm

Ø mm

GLR 50 1.11050.\_  
GLR 75 1.11075.\_  
GLR 110 1.11110.\_

70  
225  
450

20  
22  
25

175  
800  
1750

17  
19  
22

175  
800  
1750

22  
24  
27

175  
800  
1750

22  
24  
27

50  
84  
123

You will find matching studs on page 19.  
For more information please visit our website.

These interchangeable leveling sockets make AirLoc GLRN levelers can be economically and flexibly deployed. The levelers can be raised up to +13 mm in height. Depending on the leveler socket in use, the connection to your machine can be bolted, anchored or custom designed as you require.

Ask us also about our custom solutions for your specific machine.

Order no. =  
article no. + index

Color:  
Reseda green RAL 6011

Other colors  
upon request

### The Best

For laboratory instruments, passive placement of sensitive devices and machine placement in tiers. Best vibration isolation despite low installation height.

### The Stabiliser

For transport lines and special machines. Excellent constant leveling stability and overall stability. Very low installation height.

### The Universal

For tool, plastic and textile machines, graphic and general production machines. Superior isolation and damping properties. Excellent non-skid properties.

### The Dynamic One

For machines with high static load. Excellent leveling stability and high overall stability even with great disturbance forces.

Pad type  
Index

**B1**

.....50

**711**

.....92

**716**

.....56

**915**

.....65

Dimension

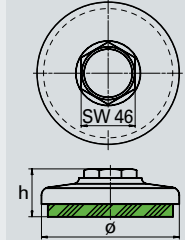
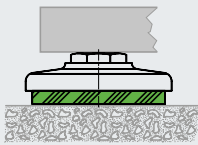

Type	Article no.	Load daN	h mm	Load daN	h mm	Load daN	h mm	Load daN	h mm	Ø mm	Leveling socket
GLRN 115	1.14115.____	350	47	1500	44	1500	49	3000	49	121	ø23
GLRN 155	1.14155.____	700	49	3000	46	3000	51	5000	51	162	
GLRN 235	1.14235.____	1750	55	5000	52	5000	57	5000	57	248	
GLRN 116	1.14116.____	350	47	1500	44	1500	49	3000	49	121	M20
GLRN 156	1.14156.____	700	49	3000	46	3000	51	5000	51	162	
GLRN 236	1.14236.____	1750	55	5000	52	5000	57	5000	57	248	
GLRN 117	1.14117.____	350	47	1500	44	1500	49	3000	49	121	
GLRN 157	1.14157.____	700	49	3000	46	3000	51	5000	51	162	
GLRN 237	1.14237.____	1750	55	5000	52	5000	57	5000	57	248	

### Stud type S for GLV, GLR, and GLRN Jacmount® Adjustable Levelers and for TA/SL heavy duty dowels, page 35.

Blue zinc-plated. Delivery with 2 nuts + 2 washers

Thread	Order no. L 100 mm	Order no. L 125 mm	Order no. L 150 mm	Order no. L 200 mm	Order no. L 250 mm	Order no. L 300 mm	SW mm
M10	9.00102		9.00104				7
M12	9.00122	9.00123	9.00124	9.00126			8
M16	9.00162	9.00163	9.00164	9.00166			10
M20	9.00202	9.00203	9.00204	9.00206			13
M24			9.00244	9.00246	9.00247	9.00248	17

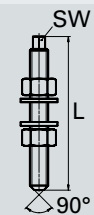

Didn't find the right thread? Ask about our low-priced custom M10 – M30 screws in lengths of 75 to 500 mm. For more information please visit our website.

The stainless steel AirLoc PRGI Jacmount® Adjustable Levelers are permanently attached to the leveling screw by means of a patented lock and yet are flexible enough that ground unevenness up to 4° can be leveled. Ideally suited to the food and chemical industries.

The economical, stainless steel AirLoc GLRI Jacmount® Adjustable Levelers are deployed when dependable vibration and impact sound isolation is required for machines that have suitable fastening holes in the machine foot. The mounting sink is shaped so that ground unevenness is leveled.

**Ask us also about our custom solutions for your specific machine.**

Order no. =  
article no. + index

Stainless steel  
INOX 1.4301

**The Best**

Passive placement of sensitive devices and machine placement in multi storied buildings. Best vibration isolation despite low installation height.

**The Universal**

For tool, production, plastic and textile machines. Superior isolation and damping properties. Excellent non-skid properties.

**The Stabiliser**

For transport lines and special machines. Excellent constant leveling stability and overall stability.

Pad type  
Index

**410**

\_.\_\_\_\_.45

**710**

\_.\_\_\_\_.91

**910**

\_.\_\_\_\_.75

**Dimension**

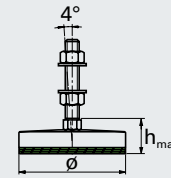
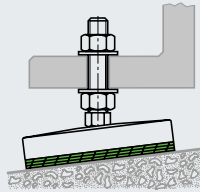

Type Article no.

Load daN h max. mm

Load daN h max. mm

Load daN h max. mm

Ø Leveling screw mm

PRGI 50 1.19141.\_\_\_\_  
PRGI 70 1.19142.\_\_\_\_  
PRGI 100 1.19144.\_\_\_\_  
PRGI 120 1.19146.\_\_\_\_

100 38  
300 48  
600 48  
1000 48

200 38  
450 48  
1000 48  
1500 48

400 38  
1000 48  
2000 48  
3000 48

51 G1  
76 G2  
107 G2  
132 G2

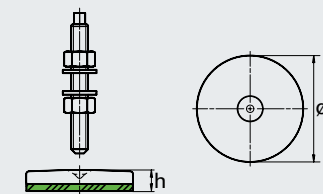
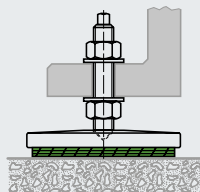

Type Article no.

Load daN h mm

Load daN h mm

Load daN h mm

Ø mm

GLRI 50 1.19111.\_\_\_\_  
GLRI 70 1.19112.\_\_\_\_  
GLRI 100 1.19114.\_\_\_\_  
GLRI 120 1.19116.\_\_\_\_

100 17  
300 17  
600 19  
1000 21

200 17  
450 17  
1000 19  
1500 21

400 17  
1000 17  
2000 19  
3000 21

51  
76  
107  
132

On request, the stainless steel PRGI and GLRI type Jacmount® Adjustable Levelers can also be delivered in acid-resistant quality, material no. 1.4435. We would be pleased to advise you. **You will find the matching special studs and studs on page 21.** For more information please visit our website.

# PR Jacmount® Adjustable Levelers – thermoplastic

The PR series of AirLoc Jacmount® Adjustable Levelers are made of reinforced thermoplastic. They are excellently suited to light machinery and applications requiring a high level of cost-efficiency. The studs of the PR levelers are quickly mounted and permanently anchored in the leveler, yet so flexible that ground unevenness up to 4° can be balanced. The damping pads can be individually selected to meet your requirements.

Ask us also about our custom solutions for your specific machine.

Order no. =  
article no. + index

Color:  
Jet black RAL 9005

### The Best

For light-weight systems and laboratory instruments which require a very high level of effective isolation.

### The Universal

For light-weight machines which demand excellent damping properties.

### The Stabiliser

For light-weight machines and systems requiring superior leveling stability and very good overall stability.

Pad type  
Index

**B1**

\_.\_\_\_\_.50

**710**

\_.\_\_\_\_.91

**910**

\_.\_\_\_\_.75

Dimension

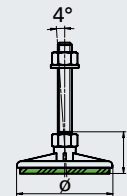
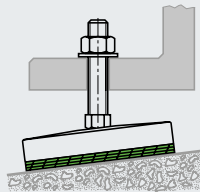

Type	Article no.	Load daN	h mm	Load daN	h mm	Load daN	h mm	Ø mm
PR 50	1.13050-9005.____	100	33	100	30	100	30	57
PR 75-2	1.13076-9005.____	225	38	500	35	500	35	82

### Special studs type U for PR Jacmount® Adjustable Levelers

Blue zinc-plated. Delivery includes nut + washer

Thread	Order no. for PR 50		Order no. for PR 75-2	
	L 100 mm	L 150 mm	L 100 mm	L 150 mm
M10	9.04102	9.04104	9.04102.02	9.04104.02
M12	9.04122	9.04124	9.04122.02	9.04124.02
M16			9.04162	9.04164

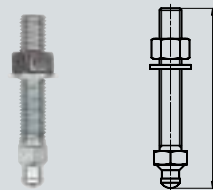

### INOX special studs G1 and G2 for PRGI Jacmount® Adjustable Levelers

INOX 1.4305. Delivery with 2 nuts + 2 washers

Thread	Order no. G1	Order no. G2	L mm	H mm	SW mm
M10	9.56102		100	42	13
M12	9.56122		100	44	13
M16	9.561621		100	54	17
M16		9.561622	100	54	19
M20		9.56202	100	60	22
M24		9.56242	100	71	24

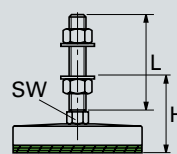

### INOX stud type S for GLRI Jacmount® Adjustable Levelers

INOX 1.4305. Delivery with 2 nuts + 2 washers

Order no. GLRI	L mm	SW mm
9.09102	100	7
9.09122	100	8
9.09162	100	10
9.09164	150	10
9.09202	100	13
9.09244	150	17



Upon request, also available in acid-resistant quality, material no. 1.4435. We would be pleased to advise you.

Ask about our low-priced custom M10 – M30 screws in lengths of 75 to 500 mm.

For more information please visit our website.

## Custom designed Jacmount® Adjustable Levelers

AirLoc offers its customers the largest selection of Jacmount® Adjustable Levelers that can be delivered on short notice. This gives our customers a technically optimal and economical choice of Jacmount® Adjustable Levelers for different applications. If there are advantages to be gained for our customers in having a custom-tailored solution, our experienced team of engineers can develop a custom Jacmount® Adjustable Leveler that perfectly suits the application or machine. Here you see just a few examples of Jacmount® Adjustable Levelers that have been successfully implemented for specific customer requirements or based on our recommendations.



### Area Jacmount® Levelers GLP and GLP-S

GLP and GLP-S Jacmount® Levelers enable wide area load distribution for floors with low load bearing capacity or when large loads have to be set down softly. This is a very efficient solution which is available using standard components in many variations.



GLP-S element without fixing screws, only with non-skid, can be freely placed under the machine.



This leveling element with large adjustment range can be used for all switch cabinet supports of various heights. Machine installations are made easier since only one uniform leveling element is necessary for the different switch cabinet versions.

Leveling can be performed very quickly and easily. The floor surface is fitted with a non-skid layer.

**GLRN 100 – M42 x 1.5**

This leveling element was developed for a customer who did not need vibration isolation. Top priority was a low-cost, precise installation of his machine. Both development objectives were optimally achieved with this leveling element.

**GLR 130, GLR 135 and GLR 136**

These special round elements have particularly large centring holes specified by the customer. They enable the use of special machine screws (e.g. hollow screws) of the customer and increase flexibility when setting up the machine.



## Wedgmount® Precision Levelers

AirLoc offers the world's largest selection of Wedgmount® Precision Levelers. The large, even surface ensures optimal support of the machine bed. Heavy loads of up to 100 t per Wedgmount® Precision Leveler can be quickly aligned to within of  $1/100$  mm accuracy using little force. This shortens the setup time of a machine considerably.

**Of course all AirLoc Wedgmount® Precision Levelers are RoHS certified.**

We manufacture Wedgmount® Precision Levelers in our main plant. Modern manufacturing methods, such as the complete processing in one clamping operation, mean the maximum precision and tight tolerances. Our Wedgmount® Precision Levelers can therefore be easily leveled even with the heaviest loads. We do not compromise when it comes to the dependability and long service life of our products. This is why all Wedgmount® Precision Levelers designed for heavy loads are manufactured from modular cast iron (GJS 40). Guide bolts and leveling spindles are made of high-strength steels. The patented top and bottom part lock provides optimal locking adhesion. The Wedgmount® Precision Leveler always remains a cohesive unit and never falls apart into single elements even when lifted.



### Precision Wedgmount® Precision Leveler – free standing

Ideal for machines without fastening holes and for free placement under the machine bed. Available in different versions, even for especially heavy loads for special bed constructions.



### Wedgmount® Precision Levelers – bolt-on

These are used where a permanent connection to the machine bed is necessary, e.g. machines with high dynamic force, such as stamping and injection moulding machines. The milled surface guarantees a precise and long-lasting connection to the machine bed. Also available in a spherical seat version for compensating angle differences of up to 3°.



### Wedgmount® Precision Levelers – bolt-through

For machines which, due to low rigidity of the machine bed, have to be anchored to the ground, e.g. long-bed machines, boring machines, milling and machining centres. The milled surfaces guarantee a precise and long-lasting connection to the machine bed. Also available in a spherical seat version for compensating angle differences of up to 3°, e.g. for long-bed machines and uneven floors.



### Wedgmount® Precision Levelers – rigid clamp

For machines for which geometry is essential and, due to the low rigidity of the machine bed, have to be anchored in the ground without vibration isolation. The milled surfaces guarantee a precise and long-lasting connection to the machine bed. Also available in a spherical seat version for compensating angle differences of up to 3°.



## Wedgmount® Precision Levelers

AirLoc offers different fastening systems for its Wedgmount® Precision Levelers. The systems can be delivered for our bolt-on and bolt-through Wedgmount® Precision Levelers with or without spherical seat compensation. The materials and design of the systems are optimally tuned to the Wedgmount® Precision Levelers and the isolation pads. This results in a complete system that fixes your machine securely and dependably to the ground.

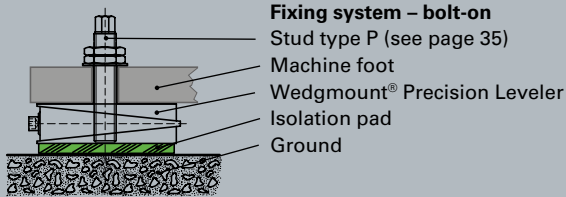

### Fixing system – bolt-on

- Stud type P (see page 35)
- Machine foot
- Wedgmount® Precision Leveler
- Isolation pad
- Ground

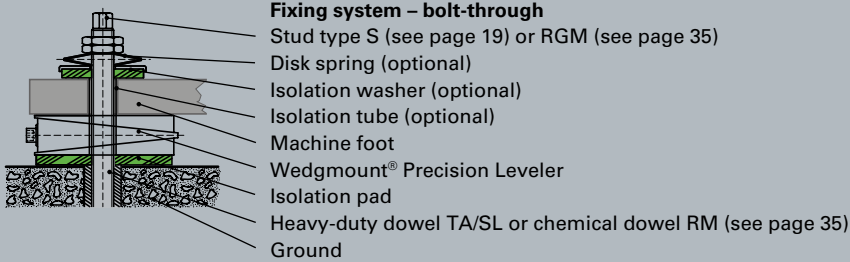

### Fixing system – bolt-through

- Stud type S (see page 19) or RGM (see page 35)
- Disk spring (optional)
- Isolation washer (optional)
- Isolation tube (optional)
- Machine foot
- Wedgmount® Precision Leveler
- Isolation pad
- Heavy-duty dowel TA/SL or chemical dowel RM (see page 35)
- Ground

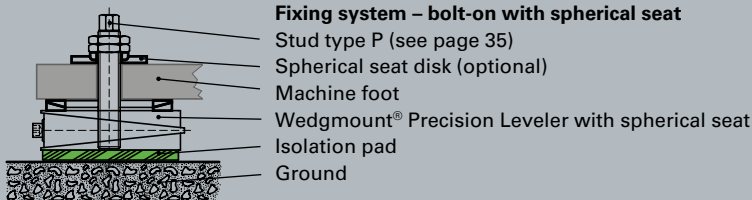

### Fixing system – bolt-on with spherical seat

- Stud type P (see page 35)
- Spherical seat disk (optional)
- Machine foot
- Wedgmount® Precision Leveler with spherical seat
- Isolation pad
- Ground

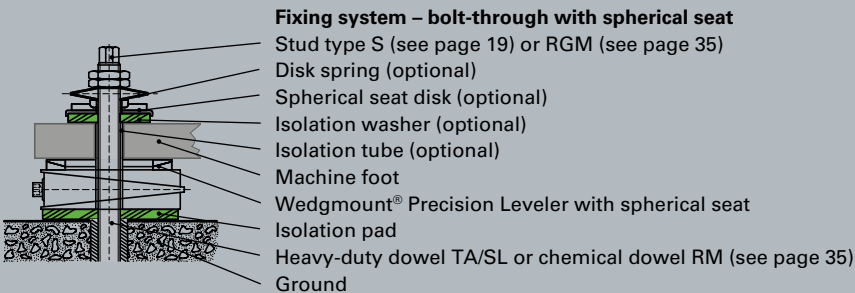

### Fixing system – bolt-through with spherical seat

- Stud type S (see page 19) or RGM (see page 35)
- Disk spring (optional)
- Spherical seat disk (optional)
- Isolation washer (optional)
- Isolation tube (optional)
- Machine foot
- Wedgmount® Precision Leveler with spherical seat
- Isolation pad
- Heavy-duty dowel TA/SL or chemical dowel RM (see page 35)
- Ground

# VRC Wedgmount® Precision Levelers – free standing

AirLoc precision Wedgmount® Precision Levelers with patented spring tensioning of top and bottom part achieve a unique lateral and longitudinal stability. Fast and easy adjustment to within 1/100 mm accuracy is possible with full machine load. This is your competitive edge when it comes to the precision and quality of your products.

Ask us also about our custom solutions for your specific machine.

Order no. =  
article no. + index

Color:  
Reseda green RAL 6011

Other colors  
upon request

**The Best**  
For passive placement of sensitive devices and machine placement in multi storied buildings. Best vibration isolation.

**The Universal**  
For tool, plastic and textile machines, graphic and general production machines. Superior isolation and damping properties. Excellent non-skid properties.

**The Dynamic One**  
For transport lines, special machines and tool machines. High load capacity, excellent constant leveling stability and overall stability.

**The Stabiliser**  
For lathes, grinding machines, boring machines, transport lines and special machines. Ideal stability and non-skid properties. Without vibration isolation.

Pad type  
Index

**NF** Top bottom  
903 B1  
.....61

**NA** Top bottom  
706 716  
.....56

**NK** Top bottom  
903 915  
.....65

**NS** Top bottom  
902 902  
.....73

Dimension

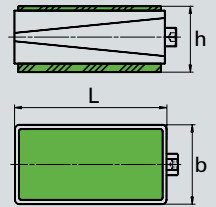
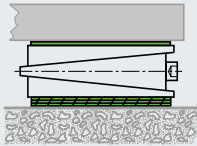

Type	Article no.	Load daN	h mm	Load daN	h mm	Load daN	h mm	Load daN	h mm	L mm	b mm	+/- h mm	
1-VRC	1.30001.____	250	54	1100	58	2000	56	2500	42	105	55	+2.5	-7
2-VRC	1.30002.____	500	54	2250	58	4000	56	5000	42	150	75	+5	-5
3-VRC	1.30003.____	1000	62	3500	66	7000	64	8000	50	200	95	+6	-6
3-VRC-72	1.30003-72.____	1000	88	3500	92	7000	90	8000	76	200	95	+6	-6
4-VRC	1.30004.____	2000	62	8000	66	14000	64	14000	50	200	200	+6	-6
4-VRC-72	1.30004-72.____	2000	88	8000	92	14000	90	14000	76	200	200	+6	-6
6-VRC	1.30006.____	1400	86	5000	90	8000	88	8000	74	115	250	+6	-10
7-VRC	1.30007.____	2000	86	8000	90	10000	88	10000	74	175	230	+8	-10
302-VRC	1.30302.____	600	56	2500	61	4500	59	4500	45	115	115	+4	-5
303-VRC	1.30303.____	1000	61	3500	66	7000	64	7000	50	140	140	+6	-6
304-VRC	1.30304.____	1300	68	5000	73	8000	71	8000	57	170	170	+5	-8
306-VRC	1.30306.____	600	83	2500	88	4000	86	4000	72	115	115	+8	-10
406-VRC	1.30406.____	1400	70	5000	74	8000	72	8000	58	115	250	+5.5	-6
407-VRC	1.30407.____	2500	81	10000	85	22500	83	22500	69	250	200	+11	-10
414-VRC	1.30414.____	3500	100	15000	104	30000	102	30000	88	300	250	+9	-9
450-VRC	1.30450.____	6000	100	25000	104	50000	102	50000	88	300	400	+9	-9

# VRC Wedgmount® Precision Leveler – free standing, 4-wedge system

AirLoc Wedgmount® Precision Levelers with 4-wedge system (types 5-VRC to 12-VRC) are constructed for heavy loads. The patented adjustment mechanism permits leveling heavy loads to within  $1/100$  mm accuracy and with a minimum of applied force.

AirLoc Wedgmount® Precision Levelers with eccentric leveling screw (types 2006-VRC to 2024-VRC) complete our programme. This is your competitive edge when it comes to the precision and quality of your products.

Ask us also about our custom solutions for your specific machine.

Order no. =  
article no. + index

Color:  
Reseda green RAL 6011

Other colors  
upon request

**The Best**  
For passive placement of sensitive devices and machine placement in multi storied buildings. Best vibration isolation.

**The Universal**  
For tool, plastic and textile machines, graphic and general production machines. Superior isolation and damping properties. Excellent non-skid properties.

**The Dynamic One**  
For transport lines, special machines and tool machines. High load capacity, excellent constant leveling stability and overall stability.

**The Stabiliser**  
For lathes, grinding machines, boring machines, transport lines and special machines. Ideal stability and non-skid properties. Without vibration isolation.

Pad type  
Index

NF      Top    bottom  
          903    B1  
.....61

NA      Top    bottom  
          706    716  
.....56

NK      Top    bottom  
          903    915  
.....65

NS      Top    bottom  
          902    902  
.....73

Dimension

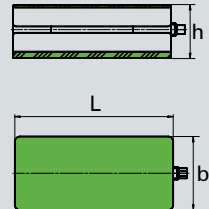
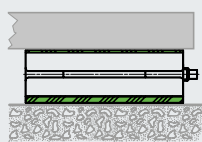

Type	Article no.	Load daN	h mm	Load daN	h mm	Load daN	h mm	Load daN	h mm	L mm	b mm	+/- h mm	
5-VRC	1.30005.____	1400	86	5000	90	10000	88	10000	74	250	115	+8	-7
8-VRC	1.30008.____	2500	86	10000	90	15000	88	15000	74	255	205	+8	-7
10-VRC	1.30010.____	4000	86	17500	90	25000	88	25000	74	370	230	+13	-7
11-VRC	1.30011.____	7000	89	30000	93	50000	91	50000	77	502	302	+12	-4
12-VRC	1.30012.____	13000	146	50000	150	100000	148	100000	134	650	400	+16	-4

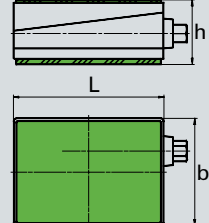
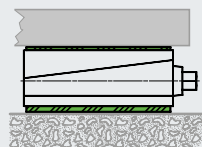

Type	Article no.	Load daN	h mm	Load daN	h mm	Load daN	h mm	Load daN	h mm	L mm	b mm	+/- h mm	
2006-VRC	1.30106.____	900	76	3500	80	6000	78	6000	64	160	115	+6	-6
2012-VRC	1.30112.____	1200	68	5000	72	10000	70	10000	56	200	120	+6	-6
2024-VRC	1.30124.____	2000	106	8000	110	15000	108	17500	94	250	160	+8	-7

For more information please visit our website.

# VRC Wedgmount® Precision Levelers – bolt-on

AirLoc bolt-on precision Wedgmount® Precision Levelers with patented spring tensioning of top and bottom part. The Wedgmount® Precision Leveler is bolted permanently onto the machine, but it can move freely on the ground and is set up with vibration isolation. The 2000 series permits bolting on centrally. The milled surface and the fast and easy adjustment to within 1/100 mm accuracy make your machinery flexible and cost-efficient. This is your competitive edge when it comes to the precision and quality of your products.

Ask us also about our custom solutions for your specific machine.

Order no. =  
article no. + index

Color:  
Reseda green RAL 6011

Other colors  
upon request

### The Universal

For tool, plastic and textile machines, graphic and general production machines. Superior isolation and damping properties. Excellent non-skid properties.

### The Dynamic One

For transport lines, special machines and tool machines. High load capacity, excellent constant leveling stability and overall stability.

### The Stabiliser

For lathes, grinding machines, boring machines, transport lines and special machines. Ideal stability and non-skid properties. Without vibration isolation.

Pad type  
Index

716

.....56

915

.....65

902

.....59

Dimension

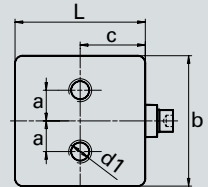
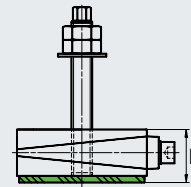
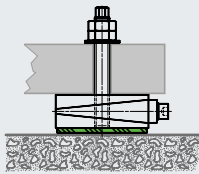

Type	Article no.	Load daN	h mm	Load daN	h mm	Load daN	h mm	Thread d1	c mm	a mm	L mm	b mm	+/- h mm
202-VRC	1.31202.____	2500	56	4000	56	4000	43	M16	58	27	115	115	+4 -5
203-VRC	1.31203.____	3500	61	6000	61	6000	48	M16	70	27	140	140	+6 -6
204-VRC	1.31204.____	5000	68	8000	68	8000	55	M20	68	27	170	170	+5 -8
205-VRC	1.31205.____	8000	77	10000	77	10000	64	M20	90	27	180	230	+9 -9
206-VRC	1.31206.____	8000	77	12000	77	12000	64	M20	90	27	205	230	+9 -9
407.1-VRC	1.31407.____	10000	80	22500	80	22500	67	M24	125	32	250	200	+11 -10
414.1-VRC	1.31414.____	15000	99	30000	99	30000	86	M24	143	41	300	250	+9 -9
450.1-VRC	1.31450.____	25000	99	50000	99	50000	86	M24	143	42	300	400	+9 -9

Other thread  
sizes upon request

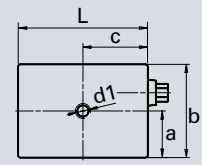
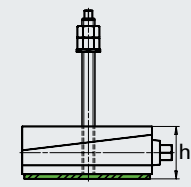
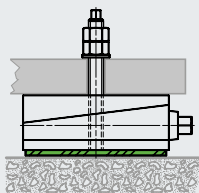

Type	Article no.	Load daN	h mm	Load daN	h mm	Load daN	h mm	Thread d1	c mm	a mm	L mm	b mm	+/- h mm
2006.1-VRC	1.31106.____	3500	75	6000	75	6000	62	M16	80	58	160	115	+6 -6
2012.1-VRC	1.31112.____	5000	67	10000	67	10000	54	M16	100	60	200	120	+6 -6
2024.1-VRC	1.31124.____	8000	105	15000	105	15000	92	M24	125	80	250	160	+8 -7

Andere  
Gewindegrößen auf Anfrage

Fixing systems suited to our Wedgmount® Precision Levelers are found on page 35.

For more information please visit our website.

# VRKC Wedgmount® Precision Leveler – bolt-on, spherical seat

AirLoc bolt-on Wedgmount® Precision Levelers in the spherical seat version with patented spring tensioning of top and bottom part. The Wedgmount® Precision Leveler is bolted permanently onto the machine, but it can move freely on the ground and is set up with vibration isolation. The 2000 series permits bolting on centrally. For machine supports that are not machined or for uneven ground, the spherical seat version guarantees a fixed connection to a slope of up to 3°. This is your competitive edge when it comes to the precision and quality of your products.

Ask us also about our custom solutions for your specific machine.

**Order no. =  
article no. + index**

**Color:  
Reseda green RAL 6011**

**Other colors  
upon request**

**The Universal**  
For tool, plastic and textile machines, graphic and general production machines. Superior isolation and damping properties. Excellent non-skid properties.

**The Dynamic One**  
For transport lines, special machines and tool machines. High load capacity, excellent constant leveling stability and overall stability.

**The Stabiliser**  
For lathes, grinding machines, boring machines, transport lines and special machines. Ideal stability and non-skid properties. Without vibration isolation.

**Pad type  
Index**

**716**  
\_.....56

**915**  
\_.....65

**902**  
\_.....59

**Dimension**

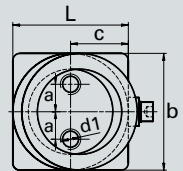
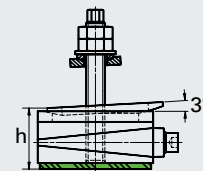
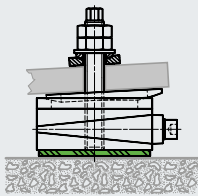

Type	Article no.	Load daN	h mm	Load daN	h mm	Load daN	h mm	Thread d1	c mm	a mm	L mm	b mm	+/- h mm
202-VRKC	1.36202._	2500	68	4000	68	4000	55	M16	58	27	115	115	+4 -5
203-VRKCV	1.36243._	3500	77	6000	77	6000	64	M16	70	27	140	140	+6 -6
204-VRKC	1.36204._	5000	84	8000	84	8000	71	M20	68	27	170	170	+5 -8
205-VRKC	1.36205._	8000	93	10000	93	10000	80	M20	90	27	180	230	+9 -9
206-VRKC	1.36206._	8000	93	12000	93	12000	80	M20	90	27	205	230	+9 -9
407.1-VRKC	1.36407._	10000	96	22500	96	22500	83	M24	125	32	250	200	+11 -10
414.1-VRKC	1.36414._	15000	134	30000	134	30000	121	M24	143	41	300	250	+9 -9
450.1-VRKC	1.36450._	25000	134	50000	134	50000	121	M24	143	42	300	400	+9 -9

Other thread sizes upon request

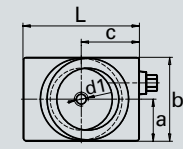
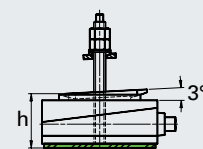
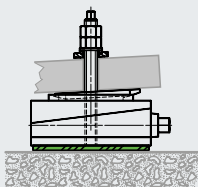

Type	Article no.	Load daN	h mm	Load daN	h mm	Load daN	h mm	Thread d1	c mm	a mm	L mm	b mm	+/- h mm
2006.1-VRKCV	1.36106V._	3500	91	6000	91	6000	78	M16	80	58	160	115	+6 -6
2012.1-VRKCV	1.36112V._	5000	83	10000	83	10000	70	M16	100	60	200	120	+6 -6
2024.1-VRKC	1.36124V._	8000	121	15000	121	15000	108	M24	125	80	250	160	+8 -7

Other thread sizes upon request

Fixing systems suited to our Wedgmount® Precision Levelers are found on page 35. For more information please visit our website.

## VRC Wedgmount® Precision Leveler – bolt-through

AirLoc bolt-through precision Wedgmount® Precision Levelers with patented spring tensioning of top and bottom part. The right choice for machines with changing loads, one-sided load bias or high dynamic disturbance forces. The 2000 series permits bolting through centrally. The Wedgmount® Precision Leveler is permanently anchored to the machine and ground and nevertheless offers highly effective vibration isolation and impact isolation. The flat surface plus fast and precise adjustment to within 1/100 mm make your machinery setup easy and economical. This is your competitive edge when it comes to the precision and quality of your products.

Ask us also about our custom solutions for your specific machine.

Order no. =  
article no. + index

Color:  
Reseda green RAL 6011

Other colors  
upon request

**The Universal**  
For tool, plastic and textile machines, graphic and general production machines. Superior isolation and damping properties. Excellent non-skid properties.

**The Dynamic One**  
For transport lines, special machines and tool machines. High load capacity, excellent constant leveling stability and overall stability.

**The Stabiliser**  
For lathes, grinding machines, boring machines, transport lines and special machines. Ideal stability and non-skid properties. Without vibration isolation.

Pad type  
Index

**716**  
.....56

**915**  
.....65

**902**  
.....59

Dimension

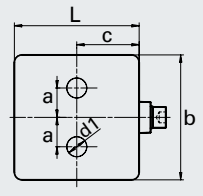
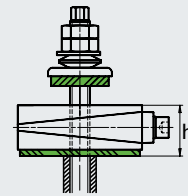
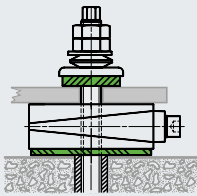

Type	Article no.	The Universal		The Dynamic One		The Stabiliser		Bore					
		Load daN	h mm	Load daN	h mm	Load daN	h mm	d1 mm	c mm	a mm	L mm	b mm	+/- h mm
212-VRC	1.32212. _	2500	56	4000	56	4000	43	22	58	27	115	115	+4 -5
213-VRC	1.32213. _	3500	61	6000	61	6000	48	22	70	27	140	140	+6 -6
214-VRC	1.32214. _	5000	68	8000	68	8000	55	26	68	27	170	170	+5 -8
215-VRC	1.32215. _	8000	77	10000	77	10000	64	26	90	27	180	230	+9 -9
216-VRC	1.32216. _	8000	77	12000	77	12000	64	26	90	27	205	230	+9 -9
407.2-VRC	1.32407. _	10000	80	22500	80	22500	67	28	125	32	250	200	+11 -10
414.2-VRC	1.32414. _	15000	99	30000	99	30000	86	28	143	41	300	250	+9 -9
450.2-VRC	1.32450. _	25000	99	50000	99	50000	86	28	143	42	300	400	+9 -9

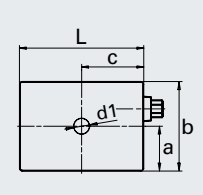
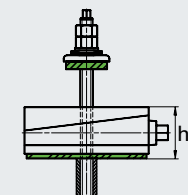
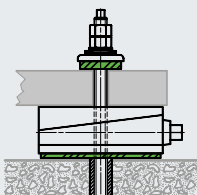

Type	Article no.	The Universal		The Dynamic One		The Stabiliser		Bore					
		Load daN	h mm	Load daN	h mm	Load daN	h mm	d1 mm	c mm	a mm	L mm	b mm	+/- h mm
2006.2-VRC	1.32106. _	3500	75	6000	75	6000	62	21	80	58	160	115	+6 -6
2012.2-VRC	1.32112. _	5000	67	10000	67	10000	54	21	100	60	200	120	+6 -6
2024.2-VRC	1.32124. _	8000	105	15000	105	15000	92	27	125	80	250	160	+8 -7

Fixing systems suited to our Wedgmount® Precision Levelers are found on page 35.  
For more information please visit our website.

# VRKC Wedgmount® Precision Leveler – bolt-through, spherical seat

AirLoc bolt-through Wedgmount® Precision Levelers in the spherical seat version with patented spring tensioning of top and bottom part. The right choice for machines with changing loads, one-sided load bias or high dynamic disturbance forces. The 2000 series permits bolting through centrally. The Wedgmount® Precision Leveler is permanently anchored to the machine and ground and nevertheless offers highly effective vibration isolation and impact isolation. For machine supports that are not machined or for uneven ground, the spherical seat version guarantees a fixed connection to a slope of up to 3°. This is your competitive edge when it comes to the precision and quality of your products.

Ask us also about our custom solutions for your specific machine.

Order no. =  
article no. + index

Color:  
Reseda green RAL 6011

Other colors  
upon request

**The Universal**  
For tool, plastic and textile machines, graphic and general production machines. Superior isolation and damping properties. Excellent non-skid properties.

**The Dynamic One**  
For transport lines, special machines and tool machines. High load capacity, excellent constant leveling stability and overall stability.

**The Stabiliser**  
For lathes, grinding machines, boring machines, transport lines and special machines. Ideal stability and non-skid properties. Without vibration isolation.

Pad type  
Index

**716**  
\_.....56

**915**  
\_.....65

**902**  
\_.....59

Dimension

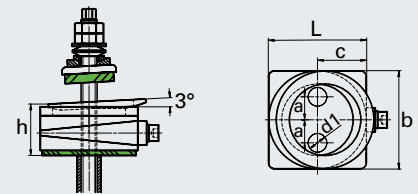
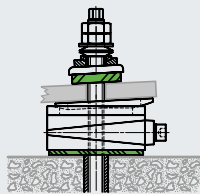

Type Article no.

Load daN h mm

Load daN h mm

Load daN h mm

Bore

d1 mm c mm a mm L mm b mm +/- h mm

212-VRKC	1.37212. _	2500	68	4000	68	4000	55	22	58	27	115	115	+4	-5
213-VRKCV	1.37243. _	3500	77	6000	77	6000	64	22	70	27	140	140	+6	-6
214-VRKC	1.37214. _	5000	84	8000	84	8000	71	26	68	27	170	170	+5	-8
215-VRKC	1.37215. _	8000	93	10000	93	10000	80	26	90	27	180	230	+9	-9
216-VRKC	1.37216. _	8000	93	12000	93	20000	80	26	90	27	205	230	+9	-9
407.2-VRKC	1.37407. _	10000	96	22500	96	22500	83	28	125	32	250	200	+11	-10
414.2-VRKC	1.37414. _	15000	134	30000	134	30000	121	28	143	41	300	250	+9	-9
450.2-VRKC	1.37450. _	24000	134	50000	134	50000	121	28	143	42	300	400	+9	-9

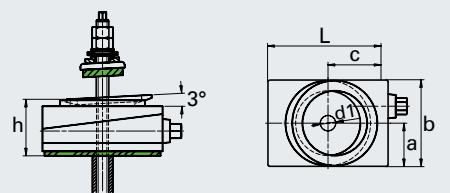
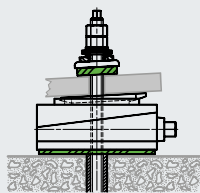

Type Article no.

Load daN h mm

Load daN h mm

Load daN h mm

Bore

d1 mm c mm a mm L mm b mm +/- h mm

2006.2-VRKCV	1.37106V. _	3500	91	6000	91	6000	78	21	80	58	160	115	+6	-6
2012.2-VRKCV	1.37112V. _	5000	83	10000	83	10000	70	21	100	60	200	120	+6	-6
2024.2-VRKC	1.37124. _	8000	121	15000	121	15000	108	27	125	80	250	160	+8	-7

Fixing systems suited to our Wedgmount® Precision Levelers are found on page 35.

For more information please visit our website.

## KSC Wedgmount® Precision Leveler – rigid clamp

AirLoc rigid clamp precision Wedgmount® Precision Levelers with patented spring tensioning of top and bottom part. The best choice when machines do not require vibration isolation and have to be connected to the ground or foundation prestressed. The 2000 series permits bolting on centrally. The milled surface and the fast and precise adjustment to within 1/100 mm accuracy make the high-precision setup of your machinery easy and economical. This is your competitive edge when it comes to the precision and quality of your products.

Ask us also about our custom solutions for your specific machine.

**Color:**  
Reseda green RAL 6011

**Other colors**  
upon request

### The Interlocker

For bore, milling, long-bed machines and for machines that have to be aligned extremely precisely in all spatial axes.

**Pad type**

**without**

**Dimension**

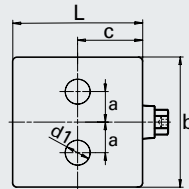
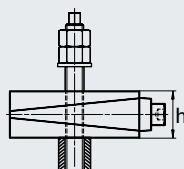
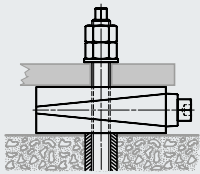

Type	Order no.	Leveling load daN	Leveling load + preload daN	Bore		c mm	a mm	L mm	b mm	+/- h mm	
				h mm	d1 mm						
2120-KSC	1.42212	5000	10000	41	22	58	27	115	115	+4	-5
2130-KSC	1.42213	7000	14000	46	22	70	27	140	140	+6	-6
2140-KSC	1.42214	8000	16000	53	26	68	27	170	170	+5	-8
2150-KSC	1.42215	10000	20000	62	26	90	27	180	230	+9	-9
2160-KSC	1.42216	20000	40000	62	26	90	27	205	230	+9	-9
414-KSC	1.42414	40000	60000	84	28	143	41	300	250	+9	-9
450-KSC	1.42450	50000	80000	84	28	143	42	300	400	+9	-9

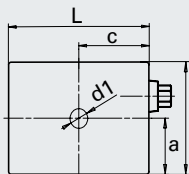
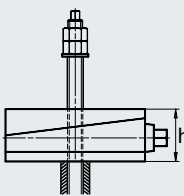
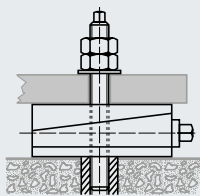

Type	Order no.	Leveling load daN	Leveling load + preload daN	Bore		c mm	a mm	L mm	b mm	+/- h mm	
				h mm	d1 mm						
2006-KSC	1.42106	6000	12000	60	21	80	58	160	115	+6	-6
2012-KSC	1.42112	12000	24000	52	21	100	60	200	120	+6	-6
2024-KSC	1.42124	25000	48000	90	27	125	80	250	160	+8	-7

Fixing systems suited to our Wedgmount® Precision Levelers are found on page 35.  
For more information please visit our website.



AirLoc rigid clamp precision Wedgmount® Precision Levelers in the spherical seat version with patented spring tensioning of top and bottom part. The best choice when machines do not require vibration isolation and have to be connected to the ground or foundation prestressed. The 2000 series permits bolting on centrally. For machine supports that are not machined or for uneven ground, the spherical seat version guarantees a fixed connection to a slope of up to 3°. This is your competitive edge when it comes to the precision and quality of your products.

Ask us also about our custom solutions for your specific machine.

### The Interlocker

For boring, milling and long-bed machines with unmachined supports and for machines that have to be aligned extremely precisely in all spatial axes.

Color:  
Reseda green RAL 6011

Other colors  
upon request

Pad type

without

Dimension

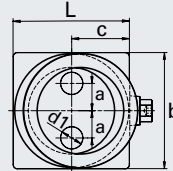
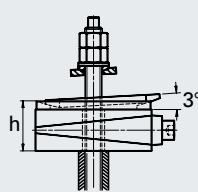
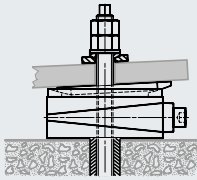

Type	Order no.	Leveling load daN	Leveling load + preload daN	Bore						Spherical seat		
				h mm	d1 mm	c mm	a mm	L mm	b mm	+/- h mm	seat Ømm	
2120-KSKC	1.47212	5000	10000	53	22	58	27	115	115	+4	-5	115
2130-KSKCV	1.47213.1	7000	14000	62	22	70	27	140	140	+6	-6	140
2140-KSKC	1.47214	8000	16000	69	26	68	27	170	170	+5	-8	140
2150-KSKC	1.47215	10000	20000	78	26	90	27	180	230	+9	-9	140
2160-KSKC	1.47216	20000	40000	78	26	90	27	205	230	+9	-9	140
414-KSKC	1.47414	40000	60000	119	28	143	41	300	250	+9	-9	190
450-KSKC	1.47450	50000	80000	119	28	143	42	300	400	+9	-9	190

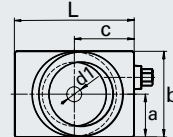
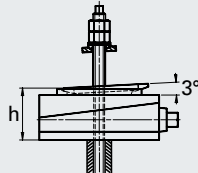
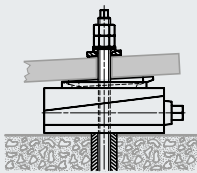

Type	Order no.	Leveling load daN	Leveling load + preload daN	Bore						Spherical seat		
				h mm	d1 mm	c mm	a mm	L mm	b mm	+/- h mm	seat Ømm	
2006-KSKCV	1.47106.1	6000	12000	76	21	80	58	160	115	+6	-6	113
2012-KSKCV	1.47112.1	12000	24000	68	21	100	60	200	120	+6	-6	113
2024-KSKC	1.47124	25000	48000	106	27	125	80	250	160	+8	-7	140

Fixing systems suited to our Wedgmount® Precision Levelers are found on page 35.  
For more information please visit our website.

You know the problem with machines and systems that are interconnected with each other. The exact anchor position is painstakingly measured, and expensive machine seat templates have to be made. The AirLoc Wedgmount® Precision Levelers in the KaBloc series permit subsequent anchoring where it is necessary once the system or machine interconnection is completely set up. This means an 80 to 90% reduction in anchoring costs. Secure this competitive advantage today and talk with us about your individual application.

Ask us also about our custom solutions for your specific machine.

Order no. =  
article no. + index

Color:  
Reseda green RAL 6011

Other colors  
upon request

### The Cost Saver

For all interconnected machines and systems. Ideal interlockability, excellent constant leveling stability and overall stability.

Pad type  
Index

903  
.....60

### Dimension

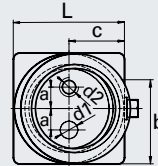
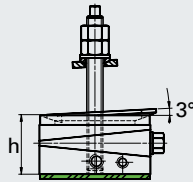
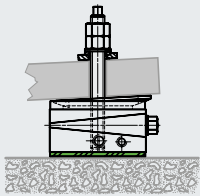

Type	Article no.	Leveling load daN	Leveling load + preload daN	Connection		Connection					+/- h	
				h mm	d1 mm	d2 mm	c mm	a mm	L mm	b mm	mm	mm
203.51V	1.34951. _	7000	14000	80	M20	22	70	27	140	140	+6	-6
203.52V	1.34952. _	7000	14000	80	22	M20	70	27	140	140	+6	-6
203.53V	1.34953. _	7000	14000	80	M20	M20	70	27	140	140	+6	-6
203.54V	1.34954. _	7000	14000	80	22	22	70	27	140	140	+6	-6

### KaBloc brackets, complete, with fastening material

Clamp force 20 kN

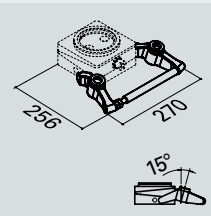
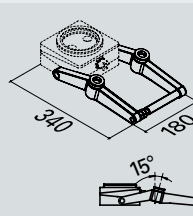

Type	Order no.	Consisting of:
AP3	1.34903	<ul style="list-style-type: none"> <li>- 2 brackets AP3</li> <li>- 2 fixing screws</li> <li>- 1 bracket stretcher with 2 M12 nuts</li> <li>- 2 spherical washer sets M20</li> <li>- 2 chemical dowels RM20</li> <li>- 2 studs RGM20 x 260 mm complete</li> </ul>

Type	Order no.	Consisting of:
AP4	1.34904	<ul style="list-style-type: none"> <li>- 2 brackets AP4</li> <li>- 2 fixing screws</li> <li>- 1 bracket stretcher with 2 M12 nuts</li> <li>- 2 spherical washer sets M20</li> <li>- 2 chemical dowels RM20</li> <li>- 2 studs RGM20 x 260 mm complete</li> </ul>

For more information please visit our website.

AirLoc fixing systems are adjusted to your AirLoc Wedgmount® Precision Levelers or your AirLoc Jacmount® Adjustable Level-ers. High-quality material from the best suppliers guarantee easy, secure mounting, reliable functioning, and long-life even under severe conditions.

## Fixing system with stud type P for bolt-on Wedgmount® Precision Levelers

## Stud type S (see page 19) and heavy-duty dowel

### Stud type P

Blue zinc-plated. Delivery includes 2 nuts + 1 washer

### Heavy-duty dowel TA/SL

Shape TA = M12 SL = M16 – M24

Thread	Order no. L			SW mm	For thread	Order no.	Hole		
	125 mm	150 mm	200 mm				Ø mm	t mm	
M12	9.01123	9.01124	9.01126	8	M12	9.41112	18	105	
M16	9.01163	9.01164	9.01166	10	M16	9.41016	24	110	
M20	9.01203	9.01204	9.01206	13	M20	9.41020	30	120	
M24			9.01246	17	M24	9.41024	35	150	
Other thread lengths upon request									

## Fixing system stud RGM and chemical dowel RM

### Stud RGM

Zinc-plated. Delivery includes 1 nut + 1 washer (M12 – M20)

### Chemical dowel RM

Type and thread	Order no.	L mm	Working length mm	SW mm	Type and thread	Order no.	Hole		Extraction force concrete B25
							Ø mm	t mm	
RGM12	9.43126	220	90	8	RM12	9.42012.1	14	110	10 kN
RGM12	9.43127	250	120	8	RM16	9.42016.1	18	125	16 kN
RGM16	9.43165	165	13	12	RM20	9.42020.1	25	170	25 kN
RGM16	9.43168	300	148	12	RM24	9.42024.1	28	210	31 kN
RGM20	9.43207	260	65	12					
RGM20	9.43209	350	155	12					
RGM24*	9.43248	300	65						
*without hexagonal + 2 nuts + 1 washer									
Other thread lengths upon request									

## Isolating washers

Type	Order no.	For thread	D mm	d mm	h mm
F905	9.20040.73	M10 – M12	40	13	8
N915	9.20060.65	M16 – M20	60	22	18
G915	9.20070.65	M20 – M24	70	26	18
Other hole sizes upon request					





Disk springs are designed by our application engineers and offered with the system. For more information please visit our website.

# Wedgmount® Precision Levelers, custom designs, accessories

AirLoc offers its customers the largest selection of Wedgmount® Precision Levelers that can be delivered on short notice. This gives our customers a technically optimal and economical choice of Wedgmount® Precision Levelers for different applications. If there are advantages to be gained for our customers in having a custom-tailored solution, our experienced team of engineers can develop a custom Wedgmount® Precision Leveler that perfectly suits your application or machine. Here you see just a few examples of Wedgmount® Precision Levelers that have been successfully implemented for specific customer requirements or based on our recommendations and help our customers to remain successful in an increasingly competitive market.



### Area Wedgmount® Precision Leveler VAP

VAP Wedgmount® Precision Levelers enable wide area load distribution for floors with low load bearing capacity or when large loads have to be set down softly. This is a very efficient solution which is available using standard components in many variations.



### Socket Wedgmount® Precision Leveler

Socket Wedgmount® Precision Levelers were developed for customers whose machines have a closed machine foot without the possibility of tightening a fixing screw. To fix the AirLoc socket Wedgmount® Precision Levelers only a blind thread is necessary in the machine foot. A sleeve is screwed in there and the leveler is simply mounted on it. This creates a strong and secure connection between Wedgmount® Precision Leveler and machine foot. And of course the leveling capability remains completely intact. Also the spherical seat variant for unevenness of up to 3° can be reliably compensated – another clever solution of our team to give our customers the competitive edge.



### KSU 3100

The Wedgmount® Precision Leveler KSU was developed for customers who needed a central fixing hole and a central adjusting screw. The leveler is constructed very robustly with a cast housing. Despite the compact and very flat construction, the leveler can level up to 5 tons. If requested, it can be added to the floor pad of each AirLoc isolation layer for optimal vibration isolation.

### Spacer for Wedgmount® Precision Levelers

For Wedgmount® Precision Levelers types	Ø mm	h mm	Order no.
202-VRKC, 212-VRKC, 2120-KSKC	115	6	9.33115.06
		12	9.33115.12
		18	9.33115.18
203-VRKC, 213-VRKC, 2130-KSKC, 203.5_V KaBloc, 204-VRKC, 214-VRKC, 2140-KSKC, 407-VRKC, 205-VRKC, 215-VRKC, 2150-KSKC, 2024 VRKC + KSKC 206-VRKC, 216-VRKC, 2160-KSKC	140	6	9.33140.06
		12	9.33140.12
		18	9.33140.18
2006.1-VRKCV, 2006.2-VRKCV, 2006-KSKCV 2012.1-VRKCV, 2012.2-VRKCV, 2012-KSKCV	113	6	9.33116.06
		12	9.33116.12

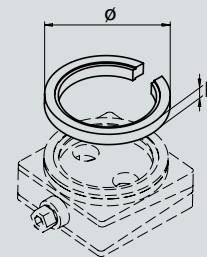

For more information please visit our website.

### Mounting Wedgmount® MSC

The mounting Wedgmounts® are for taking heavy machines or machine groups from a crane or other handling equipment. The mounting Wedgmounts® have a large leveling range.

The equipment can be easily aligned on the machined surface of the mounting shoes in the X and Y axes and then lowered onto the intended AirLoc Wedgmount® Precision Levelers and leveled in the Z axis. This is followed by the precision leveling of the machine. Now the machine is ready for use, is fixed in place and cannot be displaced, thanks to AirLoc's non-skid pads or isolation pads with their high coefficients of friction.

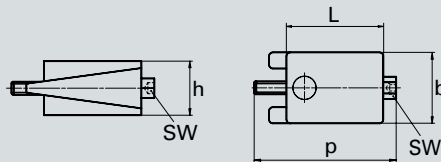

Type	Order no.	Load daN	h mm	p mm	SW mm	L mm	b mm	+/- h mm
10-MSC	1.90010	10000	62	181	19*	130	80	+10 -10
20-MSC	1.90020	20000	83	220	17/30	150	110	+14 -15

\*only outer hexagon

### Leveling screw extension for hexagon socket

The leveling screw extension permits you to level difficult to reach Wedgmount® Precision Levelers that are not positioned on the outer periphery but rather far under a machine. The choice is based on the size of the hexagon socket of the concerned SW leveling Wedgmount®.

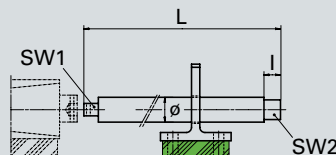

Type	Order no. L 500 mm	Order no. L 750 mm	Order no. L 1000 mm	Order no. L 1250 mm	Order no. L 1500 mm	Order no. L 1750 mm	Order no. L 2000 mm	Ø mm	SW1 mm	SW2 mm	I mm
6	9.90006.0500	9.90006.0750	9.90006.1000	9.90006.1250	9.90006.1500	9.90006.1750	9.90006.2000	15	6	13	13
10	9.90010.0500	9.90010.0750	9.90010.1000	9.90010.1250	9.90010.1500	9.90010.1750	9.90010.2000	20	10	17	14
12	9.90012.0500	9.90012.0750	9.90012.1000	9.90012.1250	9.90012.1500	9.90012.1750	9.90012.2000	20	12	17	14
14	9.90014.0500	9.90014.0750	9.90014.1000	9.90014.1250	9.90014.1500	9.90014.1750	9.90014.2000	20	14	17	14
17	9.90017.0500	9.90017.0750	9.90017.1000	9.90017.1250	9.90017.1500	9.90017.1750	9.90017.2000	24	17	19	16

Appropriate solutions are also available for outer hexagon.

For more information please visit our website.

AirLoc horizontal supports are an important part of a complete AirLoc machine setup system. Today's machines have light and compact constructions on the one hand; on the other they have fast cycle times and therefore high dynamic forces. AirLoc horizontal supports help you keep machine movements under control. The installation then remains operationally safe and reliable even in critical situations, for example during an emergency stop. It is your advantage when the machine is reliable.

Ask our specialists – we would be glad to assist you with seemingly unsolvable applications.

Order no. =  
article no. + index

Color:  
Reseda green RAL 6011

Other colors  
upon request

### The Stabiliser

High damping capability and thus fast neutralisation of machine movements.

### The Strong One

For machines with extremely high horizontal forces. Outstanding stability for lowest possible machine movements.

Pad type  
Index

NN (725 two sided)  
\_...\_.68

NL (915 two sided)  
\_...\_.66

Dimension

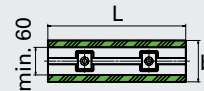
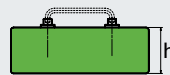

Type	Article no.	Load daN	h mm	Load daN	h mm	L mm	b mm	+/- h mm
VC/NN	1.94200._	6000	100	–	–	300	110	+9.5 -0.0
VC/NL	1.94200._	–	–	10000	100	300	90	+9.5 -0.0

### Bracket support L2 for Wedgmount® Precision Leveler VC

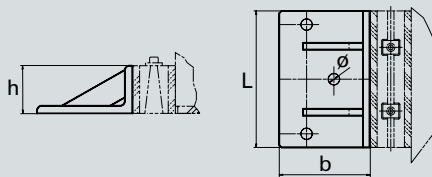

Type	Order no.	Load daN	h mm	L mm	b mm	Ø mm	Consisting of:
L2	1.941321	10000	100	300	200	25	<ul style="list-style-type: none"> <li>– 1 bracket support L2</li> <li>– 3 chemical dowels RM24</li> <li>– 3 studs RGM24 x 300</li> <li>– 6 nuts M24</li> <li>– 3 washers</li> </ul>

For more information please visit our website.

## Horizontal supports – HZA

AirLoc HZA horizontal supports are an important part of a complete AirLoc machine setup system. The delivery provides you with all required components including complete fixing materials. The threaded spindle with lock nut ensures precision adjustment of your machine geometry. The solid bracket supports guarantee a minimum of machine movement over the long-term even under maximum load. It is your advantage when the machine is reliable.

Ask our specialists – we would be glad to assist you with seemingly unsolvable applications.

### Horizontal support HZA-W2, with B 80-2/915

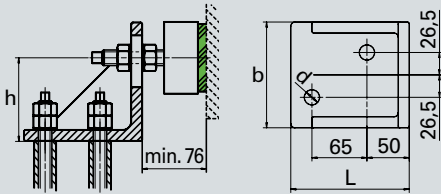
									
Type	Order no.	Load daN	h min. mm	h max. mm	L mm	b mm	Support element	d mm	Consisting of:
HZA-W2	1.94102.65	2500	75	115	140	125	B 80-2/915	18	<ul style="list-style-type: none"> <li>- 1 bracket support W2</li> <li>- 1 element B 80-2 /915</li> <li>- 1 Kukobo O-2 M16 x 150 + 2 nuts + 2 washers</li> <li>- 2 chemical dowels RM16</li> <li>- 2 studs RGM16 x 190 + 4 nuts + 2 washers</li> </ul>

### Horizontal support HZA-W4, with B 80-2/915

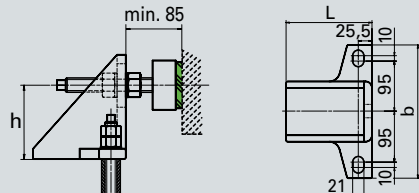
									
Type	Order no.	Load daN	h min. mm	h max. mm	L mm	b mm	Support element	Oblong hole mm	Consisting of:
HZA-W4	1.94104.65	4000	100	150	160	250	B 80-2/915	31	<ul style="list-style-type: none"> <li>- 1 bracket support W4</li> <li>- 1 element B 80-2 /915</li> <li>- 1 Kukobo O-2 M20 x 150 + 2 nuts + 2 washers</li> <li>- 2 chemical dowels RM20</li> <li>- 2 studs RGM20 x 260 + 4 nuts + 2 washers</li> </ul>

### Horizontal support, pour-in, HZA series H

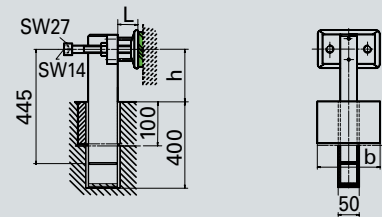
							
Type	Order no.	Load daN	h max. mm	L mm	b mm	Support element	Pour-in depth mm
HZA-H5	1.94054.65	4000	200	40-70	150	GLV115/915	400
HZA-H7	1.94075.65	6000	200	40-80	300	GLV165/915	400



### Isolation pads – press isolation example

**Arrangement:** The AirLoc isolation pads are mounted between the press foot and the installation surface of the press foundation.

**Purpose:** Active isolation, prevents propagation of disturbance vibrations in the surroundings.

**Benefits:** No negative influences on personnel due to disturbance vibrations; reduction of dynamic load peaks reduces the load on presses, tools, foundation and thereby increases service life and decreases susceptibility to faults.

**AirLoc advantages:** Isolation pads precisely customised to customer requirements for a long-life, no-wear, maintenance-free isolation concept.



### Jacmount® Adjustable Levelers – printing industry example

**Arrangement:** The AirLoc Jacmount® Adjustable Levelers are screwed onto the feet of the components with a leveling screw.

**Purpose:** Active isolation, prevents propagation of disturbance vibrations in the surroundings.

**Benefits:** Efficient isolation of the machine from the surroundings; fast, stable machine leveling.

**AirLoc advantages:** Broad selection of Jacmount® Adjustable Levelers:  
 – Elements with and without permanent connection of the leveling screw  
 – Application-specific isolation pads to fit all elements.



### Wedgmount® Precision Levelers – metal forming machine example

**Arrangement:** The AirLoc Wedgmount® Precision Levelers are under the machine feet of the machine bed.

**Purpose:** Structure-borne sound isolation, highly precise alignment of the machine, stable level setup.

**Benefits:** Highly precise leveling, high load-bearing capacity of the Wedgmount® Precision Levelers, eccentric non-skid properties thanks to high adhesion coefficients of the isolation pads.

**AirLoc advantages:** Very compact, low construction. Solution from the AirLoc system components for choice of advantages: setups, bolt-on or bolt-through, isolation variants.



### Rigid clamp Wedgmount® Precision Levelers – machining centre example

**Arrangement:** The AirLoc Wedgmount® Precision Levelers are part of the rigid clamp anchoring of the machine bed with building foundation.

**Purpose:** Stable leveling setup, strong connection of the machine bed to the building foundation, high rigidity of leveling components.

**Benefits:** Effective use of the foundation for achieving stable machine geometry.

**AirLoc advantages:** Large height adjustment range, high load-bearing leveling capacity, high precision leveling device. Strong spherical seats and spacer for uneven ground, bed surfaces, etc.



Customers who place their trust in us.



Agie Charmilles SA, Meyrin



L. Kellenberger & Co. AG, St. Gallen



Comau France, Castres



The Minster Machine Company, Minster (Ohio)



Ferag AG, Hinwil



Samputensili S.p.A., Bologna



Finn Power Lillbacka, Kauhava



Feintool Technologie AG, Lyss

For more customer references please visit our website.

Our modern infrastructure helps us manage our tasks effectively and conscientiously on a daily basis. Our in-house staff and field representatives are kept up to date through ongoing training and are highly valued by our customers as competent contacts. Periodic information sharing between the departments helps us pinpoint improvement potential that can be rapidly implemented in the company. Our customers profit from our market-driven prices, from a sensible product portfolio and comprehensive service.

### Design and laboratory



#### Design office

A design office equipped with state-of-the-art technology enables us to respond quickly to customer wishes and develop the required solutions. Naturally we design with 3D-CAD.



#### Test laboratory

Our modern equipped measurement and testing laboratory makes it possible for us to determine all parameters relevant to vibration isolation. In this way we achieve unrestricted autonomy for:

- determining the effects of all kinds of force on our products
- determining the behaviour of our products under difficult environmental influences
- performing extended load tests for our Jacmount® Adjustable Levelers and Wedgmount® Precision Levelers
- constantly monitoring the properties of our isolation pads.



### Sales, Customer Service and Quality Management



#### Sales management

Our sales managers communicate daily with the worldwide network of AirLoc representatives and sales partners. Having our finger on the market pulse is indispensable and serves as the basis for our customer-oriented product planning.



#### The Office

Our office processing staff form the hub between customers and internal order completion. Friendly and competent staff have excellent product knowledge. Their dependability and accuracy when drawing up and processing customer contracts guarantees smooth and effective order handling. Our customers profit from correctly provided goods and on schedule deliveries.



#### Quality management

We are one of the first companies in the market since 1995 to have our company and manufacturing processes periodically certified (ISO 9001:2000) by independent auditors.

Furthermore, our ongoing internal improvement processes enable us to pinpoint and implement improvement potential rapidly.



We manufacture at our Oetwil am See location in Switzerland. This permits us to respond quickly and effectively to changing market needs so that our customers benefit every day from high deliverability.

### Production



#### Processing centre

The Jacmount® Adjustable Levelers and Wedgmount® Precision Levelers are manufactured using state-of-the-art CNC machines.



#### Automatic lathe with bar loader

Thanks to CNC automatic lathes with bar magazine and robot load changer, our products are precision manufactured cost-effectively.



#### Automatic lathe with robot loader

This automatic lathing machine with robot loader is a highly flexible and cost-effective processing system.



#### Plano-milling machine

The precision wedges of the Wedgmount® Precision Levelers are efficiently produced on plano-milling machines. A high quality product is the result.



#### Special automatic boring machine

To meet the high demands of our international customers, we use special automatic boring machines that we developed ourselves. They combine high precision manufacturing with maximum efficiency.

### Logistics, packaging, output checking and shipping



#### High-rack storage

A key factor in guaranteeing our high delivery capacity is our high-rack storage (27 m long and 10 m high) with 1,200 pallet spaces.



#### Assembling shop

Assembling of pads on Jacmount® Adjustable Levelers and Wedgmount® Precision Levelers is done in accordance with the customer's individual application conditions.



#### Output checking and shipping

After a thorough check, products are carefully packaged and sent to the customer for many years of use.

# **AirLoc**

**stops vibrations**

**AirLoc Ltd.**  
Industriestrasse 2, 8618 Oetwil am See, Switzerland  
Telephone +41 44 929 77 00  
Fax +41 44 929 77 10  
[www.airloc.com](http://www.airloc.com)  
[contact@airloc.com](mailto:contact@airloc.com)

#### **Worldwide Distributors**

Please visit us in the Internet at [www.airloc.com](http://www.airloc.com) for details about our worldwide distributors.

**AirLoc, BiLoc, KombiRoc and KaBloc are registered trademarks.**

**All information and specifications are true and correct to the best of our knowledge; they do not represent an assurance of properties and do not release users from examination on their own, also with reference to the trademark rights of third parties. Technical revisions are subject to change without prior notice.**