

Technical datasheet

Wedgmounts 4-VRC /NF

Art. no.
1.30004.61

For passive placement of sensitive devices and machine placement in multi storied buildings.
Best vibration isolation.

Max. load
4500 lbs

Article information	
Type	4-VRC /NF
Name	Wedgmounts
Art. no.	1.30004.61
Color	RAL 7016 anthracite grey
Other colors upon request.	
Surface treatment	Painted

Type illustration



System description

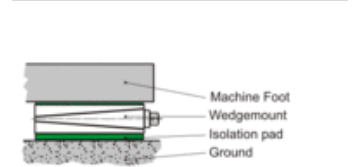

Technical Data		Dimensions	
Max. load [lbs]	4500	Height H [mm]	62
Leveling range [mm]	6	Height H_{0B} in neutral position, without pads [mm]	46
Leveling range [mm]	-6	Length L [mm]	200
Leveling distance per turn [mm]	0.2	Length L_1 [mm]	60
Temperature range from [°C]	-20	Length L_2 [mm]	42
Temperature range to [°C]	80	Length L_{max} [mm]	301
Weight [kg]	10.4	Width B [mm]	200
Pad equipment		Width across flats SW_1 [mm]	22
Bottom pad type	B1	Width across flats SW_2 [mm]	12
Pad thickness unloaded [mm]	13		
Coefficient of friction on concrete with fine mortar	0.9		
Coefficient of friction tolerance +/-	0.1		
Hardness [° Shore A]	40 - 45		
Bottom pad area A_1 [cm ²]	392		
Top pad type	903		
Pad thickness unloaded [mm]	3		
Coefficient of friction on concrete with fine mortar	0.8		
Hardness [° Shore A]	90 - 95		
Top pad area A_2 [cm ²]	392		

Dimensioned sketch

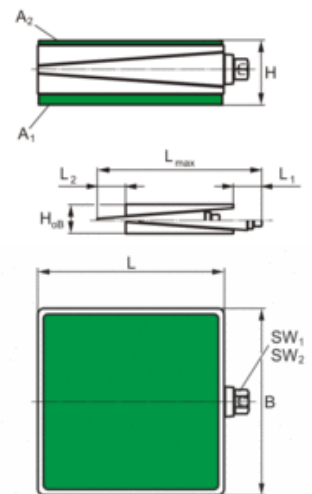

Mounting sketch

